

Cross Enterprise Document Sharing in Norway

Implementation guide for Norwegian usage of IHE XDS, XCA and XUA



HITS 1233 *draft for trial use 2020*

The publications title:

Implementation guide for Norwegian
usage of IHE XDS, XCA and XUA

Report number

HITS 1233 *draft for trial use 2020*

Published:

05/2020

Published by:

The Norwegian Directorate of eHealth

Contact:

postmottak@ehelse.no

The publication can be downloaded at:

www.ehelse.no

Content

1	Introduction	6
1.1	Background.....	6
1.2	About this document.....	6
1.3	Glossary.....	6
1.4	Normative references	7
1.5	Non-normative references	9
2	Architecture Cross Enterprise Document Sharing.....	10
2.1	Communities	14
2.2	Master patient index.....	15
2.3	Optimized queries	15
3	Cross Enterprise Document Sharing – XDS over XCA	16
3.1	General restrictions on IHE XDS profiles.....	16
3.1.1	Web Service requirements	16
3.1.2	SOAP message restrictions.....	17
3.1.3	Asynchronous Web Services Exchange Option.....	17
3.1.4	XDS Options supported.....	17
3.1.5	XCA Options supported.....	17
3.2	Extensions	17
3.2.1	Transaction-id and initiating application.....	17
3.3	Duration of each transaction.....	18
3.4	Document formats.....	18
3.4.1	XML-based document formats.....	19
3.4.2	CDA based document formats.....	19
3.4.3	CDA wrapper for non-XML documents:	19
3.4.4	Non-XML documents without CDA wrapper	19
3.4.5	Examples of valid combinations of FormatCode and MimeType.....	20
3.5	Audit logging	21
3.5.1	Consistent time	22
3.5.2	Actors and transactions in IHE ATNA	22
3.5.3	Message category elements.....	23
3.5.4	Audit logging in XDS/XCA	25
3.5.5	Event.....	27
3.5.6	Human requestor (agent)	29
3.5.7	Source and Destination (agent)	30
3.5.8	Audit Source (source).....	32

3.5.9	Patient (entity)	34
3.5.10	Query Parameters (entity)	35
3.5.11	Document (entity)	38
3.5.12	Transaction-id and initiating application (entity)	40
3.5.13	Accounting of disclosure.....	41
3.6	ITI-18 Registry Stored Query.....	51
3.6.1	Parameters for stored query FindDocuments	51
3.6.2	Parameters for stored query GetDocuments	57
3.6.3	Response	57
3.6.4	Audit log	58
3.7	ITI-43 Retrieve Document	59
3.7.1	Request.....	59
3.7.2	Response	60
3.7.3	Audit log	60
3.8	ITI-38 Cross Gateway Query	62
3.8.1	XDS Affinity Domain Option is required for all Initiating Gateways.....	62
3.8.2	Audit log	63
3.9	ITI-39 Cross Gateway Retrieve	64
3.9.1	XDS Affinity Domain Option is required for an Initiating Gateway	64
3.9.2	Audit log	65
4	XUA – Cross-Enterprise User Assertion	66
4.1	XUA roles	67
4.1.1	X-Service User	67
4.1.2	X-Service Provider	67
4.1.3	X-Assertion Provider	67
4.1.4	User Authentication Provider	68
4.2	Transactions	68
4.2.1	Authenticate User.....	68
4.2.2	Get X-User Assertion	68
4.2.3	Provide X-user Assertion – ITI-40.....	70
4.3	Summary.....	70
4.4	XUA SAML User Assertion.....	72
	Annex - Example messages (not normative).....	83
5.1	ITI-18 + ITI-40 Request	83
5.2	ITI-18 response	86
5.3	ITI-43 + ITI 40 request.....	93
5.4	ITI-43 response	96

5.5	ITI-38 + ITI-40 request	100
5.6	ITI-38 response	103
5.7	ITI-39 + ITI-40 request	113
5.8	ITI-39 response	116
5.9	AuditEvent for ITI-18 initiated from a Document Consumer	119

1 Introduction

1.1 Background

Cross enterprise document sharing is a new form of collaboration between health professionals and between health professionals and citizens in Norway. Cross enterprise document sharing in the Norwegian healthcare sector enables the transfer of knowledge between health professionals working in different health organizations. Document sharing facilitates a more efficient interaction throughout the patient process.

The main objectives of document sharing are:

- Facilitate that health professionals can make necessary access to referrals, discharge summaries and other types of reports stored in other healthcare organizations to achieve more effective health care decisions and reduce errors.
- Reduce the administrative burden and costs of today's collection and delivery of health information.
- Increase the overview of available health information across enterprises.
- Enable access to patients to their medical records throughout Norway.

To implement document sharing in the Norwegian health care, interoperability between each actor is mandatory. The goal of this document is to achieve a common understanding of how document sharing must be implemented to achieve 100% interoperability between each party. The target audience of this document is technical professionals implementing solutions for document sharing.

1.2 About this document

This document describes the Norwegian usage of the IHE integration profiles based on XDS, XCA and XUA provided in Volumes 1 through 3 of the IHE IT Infrastructure Technical Framework(see chapter 01.4) in a national context. In addition, this document describes extensions and restrictions to actors and transactions in the profiles. The national extensions and restrictions are included to effectively support document sharing in healthcare in Norway.

This document is not an introduction to XDS or XCA, and it is assumed that the reader is familiar with XDS and XCA. The document will only focus on requirements from the IHE profiles which are relevant for national use in Norway. For an introduction to document sharing architecture, please read the provided "Reference architecture for document sharing" and "Target architecture for national document sharing" (see URL links in chapter 1.4, NB: in Norwegian).

Although the title of the document includes the term "implementation guide", this is not a description on how each actor implement their solutions. This document focuses on how to achieve interoperability between actors to obtain national document sharing by operationalization of the international standards IHE XDS, XCA, XUA and ATNA.

1.3 Glossary

Key terms used in this document are described in the table below.

Term	Description
EHR	Electronic Health Record
Helsenorge	Public website for citizens and patients in Norway
Kjernejournal	A national solution for a patient's summary Care Record which is a collection of the patient's health records. Health professionals are users of this solution. Especially used when in need of urgent medical access. This solution will also be used for national cross enterprise document sharing.
HelseID	HealthID is a joint login solution for the healthcare sector in Norway. It facilitates one-time access for health professionals with only one electronic ID (e-ID) throughout the health service, and to facilitate the sharing of data and documents by the healthcare sector.
XACML	eXtensible Access Markup Language
OASIS	Advancing open standards for the information society
IHE	Integrating the Healthcare Enterprise. IHE is an initiative by healthcare professionals and industry to improve the way computer systems in healthcare share information.
ATNA	Audit Trail and Node Authentication
XUA	Cross Enterprise User Assertion
XDS	Cross Enterprise Document Sharing
XCA	Cross Community Access
SAML	Security Assertion Markup Language
ebRIM	ebXML Registry Information Model v3.0, OASIS Standard 2005 This standard defines the types of metadata and content that can be stored in an ebXML Registry.

1.4 Normative references

The national extensions and restrictions documented in this document shall be used in conjunction with the definitions and requirements of integration profiles, actors and transactions provided in Volumes 1 through 3 of the IHE IT Infrastructure Technical Framework.

Normative references are listed in the Table 1:

Table 1 List of normative references

Name	version	Reference
Volume 1 (ITI TF-1) Integration Profiles	Revision 16.0 July 12, 2019	http://www.ihe.net/uploadedFiles/Documents/ITI/IHE_ITI_TF_Vol1.pdf
Volume 2a (ITI TF-2a) Transactions Part A	Revision 16.0 July 12, 2019	https://www.ihe.net/uploadedFiles/Documents/ITI/IHE_ITI_TF_Vol2a.pdf
Volume 2b (ITI TF-2b) Transactions Part B	Revision 16.0 July 12, 2019	https://www.ihe.net/uploadedFiles/Documents/ITI/IHE_ITI_TF_Vol2b.pdf
Volume 2x (ITI TF-2x) Volume 2 Appendices	Revision 16.0 July 12, 2019	https://www.ihe.net/uploadedFiles/Documents/ITI/IHE_ITI_TF_Vol2x.pdf
Volume 3 IHE ITI TF-3 Cross-Transaction Specifications and Content Specifications	Revision 16.0 July 12, 2019	https://www.ihe.net/uploadedFiles/Documents/ITI/IHE_ITI_TF_Vol3.pdf
IHE XDS metadata: Norsk profil av IHE XDS.b (Norwegian profile IHE XDS.b metadata)	HIS 1169:2016 Revision: 15.12.2018 (in Norwegian)	https://ehelse.no/standarder/ihe-xds-metadata-norsk-profil-av-ihe-xds.b
Add RESTful ATNA (Query and Feed)	Rev. 3.1 – Trial Implementation August 15, 2019	https://www.ihe.net/uploadedFiles/Documents/ITI/IHE_ITI_Suppl_RESTful-ATNA.pdf
Cross-Community Patient Discovery (XCPD)	Rev. 2.9 – Trial Implementation, July 24, 2018	https://www.ihe.net/uploadedFiles/Documents/ITI/IHE_ITI_Suppl_XCPD_HDL_Revoke_Option.pdf

1.5 Non-normative references

Table 2 List of non-normative references

Name	version	Reference
Målarkitektur for Nasjonal dokumentdeling (Target architecture: national document sharing)	HITR 1222:2019 (03/2019). (In Norwegian)	https://ehelse.no/standarder/ikke-standarder/malarkitektur-for-dokumentdeling
Referansearkitektur for dokumentdeling (Reference architecture: document sharing)	HITR 1214:2018 (12/2018) (in Norwegian)	https://ehelse.no/standarder/ikke-standarder/referansearkitektur-for-dokumentdeling
Cross-enterprise Sharing of Scanned Documents		https://www.ihe.net/uploadedFiles/Documents/ITI/IHE_ITI_TF_Vol3.pdf#nameddest=5_2_Scanned_Documents_Content_M

2 Architecture Cross Enterprise Document Sharing

The Norwegian Directorate of eHealth (NDE) has published a target architecture for national document sharing in the Norwegian healthcare sector (see link in chapter 01.4). The architecture is based on the creation of several regional and local communities, in addition to a national community. Each community must be connected through gateways supporting IHE XCA transactions.

The described target architecture for documents sharing must be achieved through a roadmap which includes several phases and projects. The roadmap is not yet in place and this chapter describes the architecture for only the first phase of a future defined roadmap.

In this first phase we will only have two document consumers; Helsenorge.no, the citizen health portal and Kjernejournal (Summary Care Record) for health professionals.

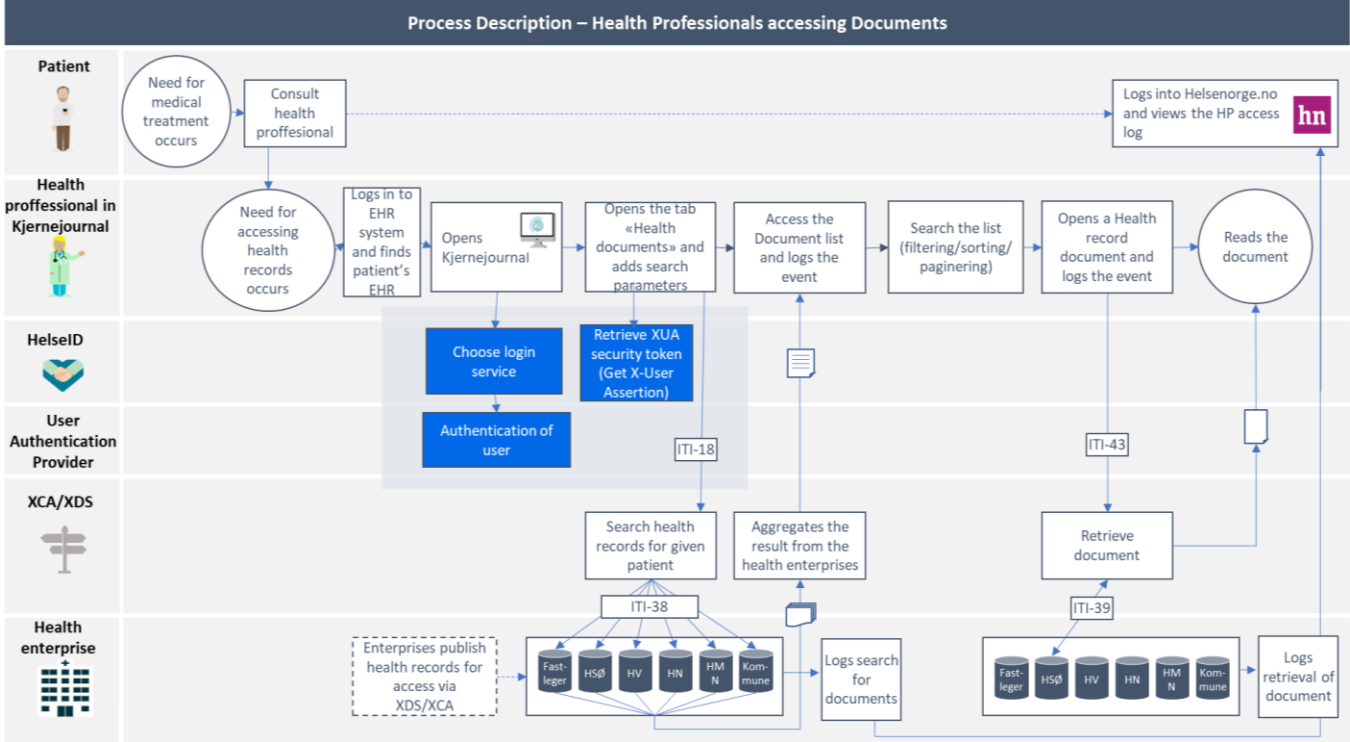

Figure 1 describes how cross enterprise document sharing in Norway for health professionals through usage of Kjernejournal will be achieved in the first phase.

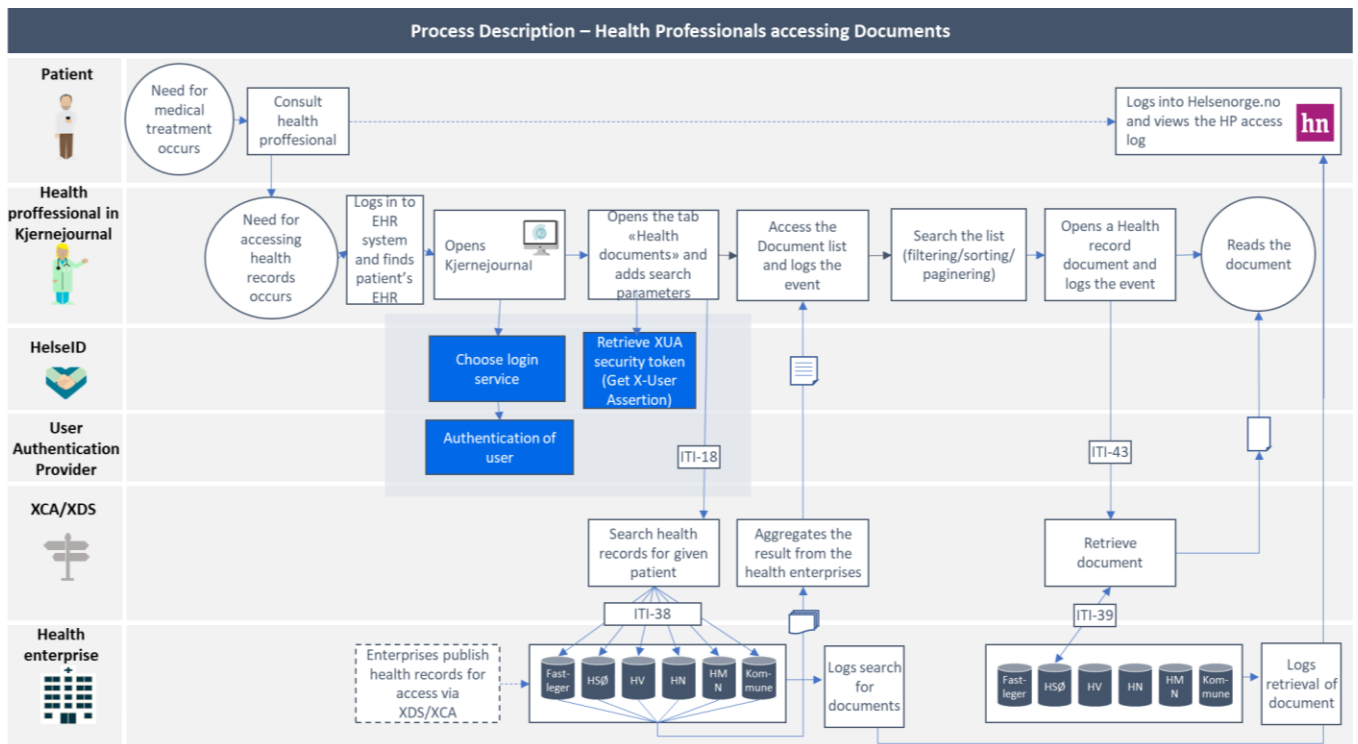

Figure 1 Process description of document sharing through usage of Kjernejournal (summary care record) for health professionals.

Figure 2 shows the IHE defined roles and transactions relevant for the Norwegian cross enterprise document sharing. An important clarification and refinement is that this document is not a profiling of IHE XDS usage inside an IHE XDS affinity domain. This document only focuses on IHE XDS usage in a national perspective, where IHE XCA is chosen to connect communities together.

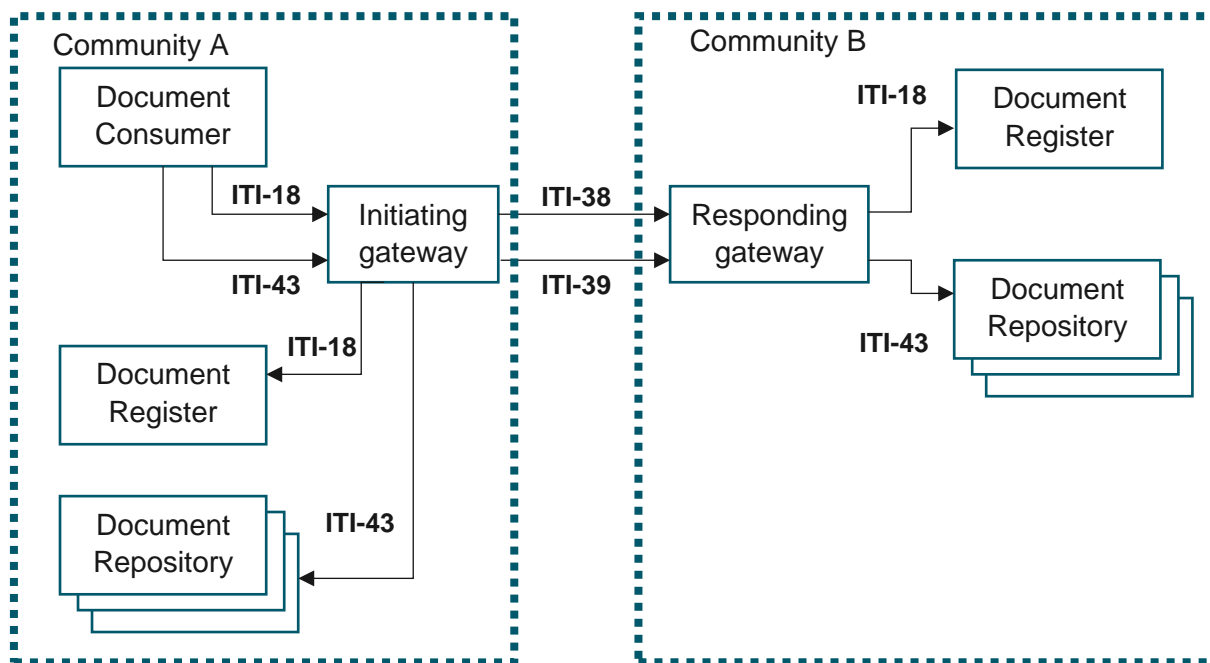

Figure 2 IHE ITI XDS and XCA transactions in use in this guide.

Table 3 Explanation of Figure 2:

Transaction/Role	Description
Community	<p>IHE defines community as a coupling of facilities/enterprises that have agreed to work together using a common set of policies for the purpose of sharing clinical information via an established mechanism.</p> <p>A community has at least one unique home community ID. A community can consist of a hierarchy of communities. Membership of a facility/enterprise in one community does not preclude it from being a member in another community.</p> <p>Each community must comply to the Norwegian IHE XDS metadata profile (see chapter 1.4).</p> <p>A community must offer query (ITI-38) and retrieval of a patient's documents (ITI-39) to other communities. A community could be an IHE XDS Affinity domain as described in IHE XDS, but IHE XCA do not require a community to be XDS compliant.</p>
Document Consumer	<p>Query and retrieve documents on behalf of the initiating user. A Document Consumer must use ITI-18 and ITI-43 against an Initiating Gateway to query and retrieve a patient's documents across all existing communities.</p>
Initiating Gateway	<p>Responsible for querying a patient's documents in all other communities. Based on a received ITI-18 query, the Initiating Gateway calls every</p>

Transaction/Role	Description
	known Responding Gateways with ITI-38 and aggregates each result to answer the ITI-18 query.
Responding Gateway	<p>A Responding gateway accepts only requests from other Initiating gateways. It must accept ITI-38 queries and ITI-39 retrievals of documents.</p> <p>IHE XCA does not describe requirements on how the integration between a Responding gateway and the community's Document register and repositories is done. This guide requires that each responding gateway use XDS transactions ITI-18 and ITI-43.</p> <p>The IHE XCA specification allows a responding gateway to serve multiple communities and a community can have multiple responding gateways.</p>
Document Register	<p>A Document Register stores a community's document metadata. It must, as a minimum, accept ITI-18 queries.</p> <p>A Register must comply to the Norwegian IHE XDS metadata profile.</p> <p>In an XCA context a Register is not required to have support for queries for Submission Sets, Folders or Associations. The only required stored queries are "FindDocuments" and "GetDocuments". This is further elaborated in chapter 3.6.</p>
Document Repository	<p>A Document Repository stores clinical documents and must support retrieval of a patient's documents through the transaction ITI-43.</p> <p>The document formats supported by the Repository must comply to the allowed combination of Format code and Mime type described in chapter 3.4</p>
ITI-18	Registry Stored Query. Roles that must support this transaction: Document Consumer, Initiating Gateway, Responding Gateway and Document Register.
ITI-43	Retrieve Document Set. Roles that must support this transaction: Document Consumer, Initiating Gateway, Responding Gateway and Document Repository.
ITI-38	Cross Gateway Query. Roles that must support this transaction: Initiating Gateway and Responding Gateway
ITI-39	Cross Gateway Retrieve. Roles that must support this transaction: Initiating Gateway and Responding Gateway

Figure 3 shows the architecture for the first phase of national document sharing in Norway. In this phase the main goal is to connect the Regional Health authorities as communities. When implemented, each community will be sharing its EHR documents with users in Kjernejournal

and Helsenorge. In a next phase the architecture could easily be extended to include other communities and new document consumers.

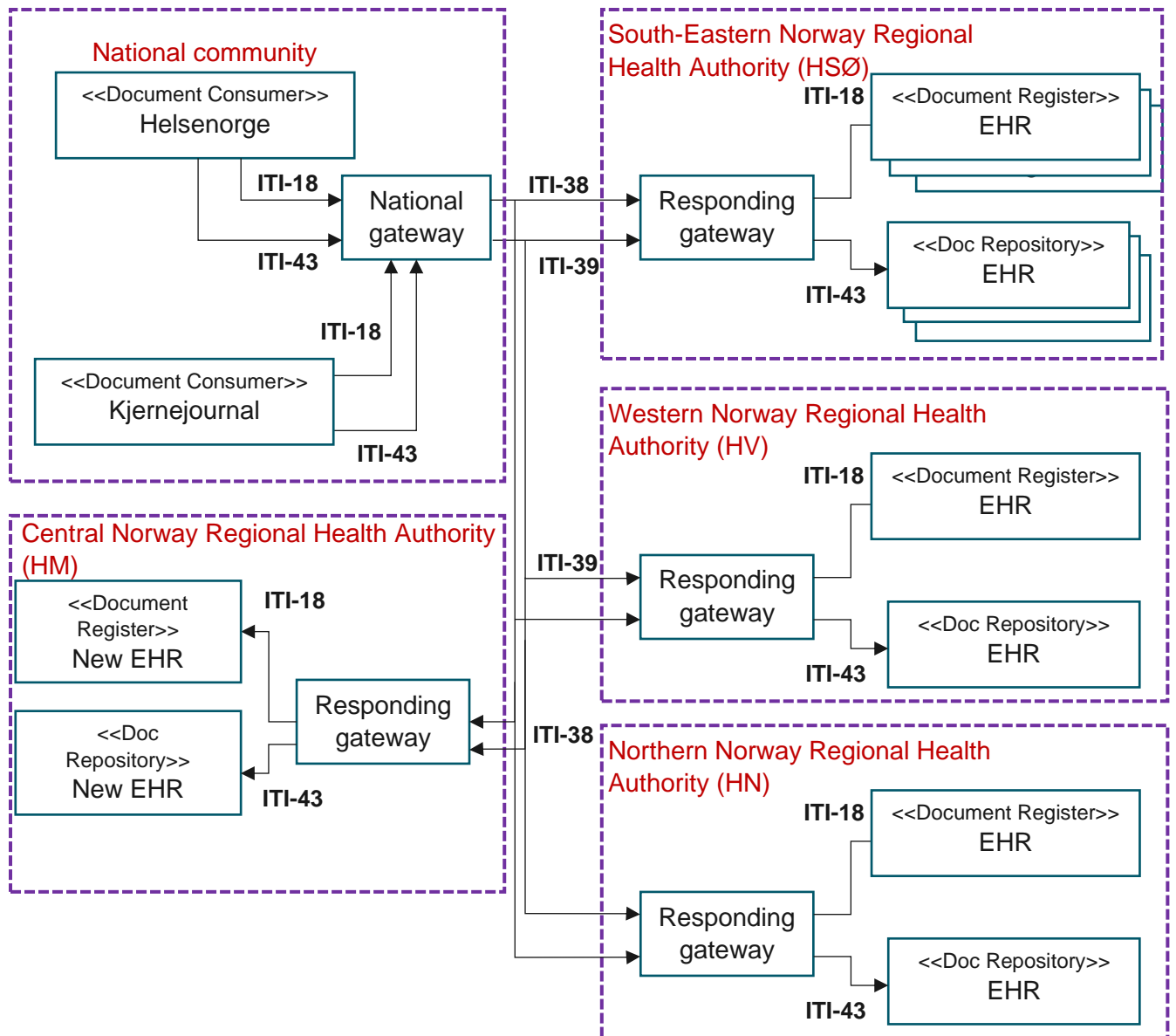

Figure 3: First phase of national document sharing in Norway where the Regional Health authorities are connected with Kjernejournal and Helsenorge

2.1 Communities

An IHE XCA architecture consists of different communities, and XCA describes how these communities should be connected. Figure 3 shows an architecture with five communities, each of the four national health regions and one national community. This architecture could easily be expanded to other types of communities, if necessary.

IHE XCA specifies that each of these communities must have a unique homecommunity ID. Each Initiating gateway must have a list of all the communities with their respective homecommunity IDs and their endpoints to IHE XCA transaction APIs.

The Norwegian profile of IHE XDS metadata defines the use of OIDs for identifying communities. The Norwegian Directorate of eHealth (NDE) governs an OID-base and can issue an OID to a community. Each Norwegian health region also governs their own OID-base and can choose to issue their own homecommunity ID.

The OID-base which NDE governs has the following OID structure for document sharing:

- 2.16.578.1.12.4.1.7 – Document sharing root governed by NDE
 - 2.16.578.1.12.4.1.7.1 – Community base OIDs governed by NDE
 - 2.16.578.1.12.4.1.7.1.1 – National community
 - 2.16.578.1.12.4.1.7.1.x – other communities issued by NDE (none issued yet)
 - 2.16.578.1.12.4.1.7.2 – SAML Assertion metadata base OID

2.2 Master patient index

The concept of a master patient index (MPI) is a rather broad concept, yet it is most often associated with the creation of a master patient identifier domain. In Norway, we use master patient identifiers which is used nationwide. Therefore, we have at this stage not seen any need to include usage of the IHE profiles: Patient Identifier Cross-referencing (PIX) and Patient Demographics Query (IHE PDQ). These profiles exist also in HL7 FHIR based versions (IHE PIXm and IHE PDQm).

For future needs, such as usage of patient identifiers from other EU countries or use of temporary identifiers, it could become relevant to consider usage of these profiles. In addition, it is relevant to consider these profiles for quality assurance of correct linking between patient identifier and the patient itself.

2.3 Optimized queries

Use of IHE XCA requires an Initiating Gateway to always send document queries to every existing responding gateway. South-Eastern Norway Regional Health Authority covers about half the population in Norway. It is probably not effective to send all queries to all communities. And since our document sharing architecture is not including a national master patient index register, holding information on where to find patients' documents, other measures to optimize queries must be evaluated.

A possible solution is to use the IHE standard Cross-Community Patient Discovery (IHE XCPD). IHE XCPD supports the means to locate communities that hold patient relevant health data across communities. The Cross Gateway Patient Discovery transaction ITI-56 supports the ability for Initiating Gateways to request a list of communities which may have healthcare data about the identified patient.

Description of usage of IHE XCPD:

When an Initiating Gateway receives a document query (ITI-18) for a given patient, it requests all Responding Gateways with an ITI-56 Patient Location Query. Each Responding Gateway must work out whether they have any health data about the requested patient and send a negative or positive response back to the Initiating Gateway. The Initiating Gateway will make a list of communities responding positively, and then send an ITI-38 to these communities.

When acquiring/implementing a Responding Gateway, communities should ensure that the solution supports processing an ITI-56 Patient Location Query.

3 Cross Enterprise Document Sharing – XDS over XCA

This chapter describes extensions and restrictions to IHE XDS and XCA transactions for the national usage of document sharing. In addition, it describes the content of audit message for each actor and transaction (chapter 3.5)

3.1 General restrictions on IHE XDS profiles

To achieve national usage of document sharing the architecture is based on communities as described in chapter 2.1. This is described in detail in the document describing the target architecture (see chapter 1.4 for reference to this document). Each community must comply to the IHE XCA profile. According to IHE XCA, each community is not required to be a compliant XDS affinity domain. However, each community must be compliant to the Norwegian profile of IHE XDS.b metadata, see chapter 1.4. In addition, each community must support XCA transactions ITI-38 and ITI-39. To use these transactions, also ITI-18 and ITI-43 must be profiled since ITI-38 and ITI-39 are based on these transactions. The national focus is therefore on XDS usage over XCA to support national query and retrieval of a patient's documents.

To achieve interoperability between all parties it is required that all systems support this national profiling of IHE XCA and IHE XDS.

Since it is not required for an XCA community to be a compliant XDS affinity domain, not all XDS requirements are required to be compliant to IHE XCA. For instance, in the XDS profile support of Associations, folders and submission sets are required for Document Registers. In XCA this is not required.

With reference to chapter 3.38 Cross Gateway Query in IHE ITI-2b, the following restriction applies for Norwegian use of XDS:

National document sharing does not require support of Associations, folders and submission sets . A responding gateway can respond with zero entries when receiving queries which specifies associations, folders or submission sets.

In addition, support of the IHE XDS transaction ITI-41 and ITI-42 is not required in XCA and is therefore not included in this document.

3.1.1 Web Service requirements

IHE has described generic web service requirements for all IHE transactions in ITI TF-2x: Appendix V: Web Services for IHE Transactions. Implementors must comply with these requirements. Exceptions are described in chapter 3.1.2 and 3.1.3 in this document.

The specific web service requirements for each IHE transaction are described in ITI TF-2x: Appendix V.4 Web Services for specific IHE Transactions. Each IHE transaction in ITI TF-2a and -2b has a "Message Semantics" section. A separate subsection is added for each affected IHE transaction at the end of the "Message Semantics" section which details the types and message parts of the WSDL.

IHE has provided some IHE profiles implementation material (non-normative) which includes schema, examples, WSDL, and more. This can be found on their FTP site: ftp://ftp.ihe.net/TF_Implementation_Material/

3.1.2 SOAP message restrictions

ITI-43 Retrieve Document Set and XCA ITI-39 Cross Community Retrieve transactions require SOAP 1.2 with MTOM/XOP.

When using SOAP 1.2 MTOM/XOP the following applies:

- Usage of a MTOM/XOP wrapper
- Metadata goes in the root part which is identified by the start parameter of the content-type header
- Documents are included by the Document element (as defined by the profile)
- For national usage only un-optimized format is supported. The document contents must be included as base64 encoded value of the Document element.

ITI-18 and ITI-38 transactions require use of Simple SOAP message.

3.1.3 Asynchronous Web Services Exchange Option

In Norway, this option is not in use for national document sharing. No actor is required to implement support for this option.

3.1.4 XDS Options supported

Table 10.2-1b in IHE ITI Vol 1 shows a list of which options are available for different actors. In Norway none of these options is neither required nor supported for national usage (but could be used inside a community).

3.1.5 XCA Options supported

Table 18.2-1 in IHE ITI Vol 1 shows a list of possible options for XCA actors. In Norway only one option must be supported for each XCA community: XDS Affinity Domain Option (see chapter 18.2.1 in IHE ITI Vol 1 for more details). The other options are not supported.

In addition, grouping rules described in chapter 18.2.3 in IHE ITI VOL 1 must be supported.

3.2 Extensions

3.2.1 Transaction-id and initiating application

Transaction-id

IHE XDS and XCA only specify logging details based on transactions between two IHE defined actors. Using XDS over XCA, many actors and transactions are involved in a query or retrieval request. IHE does not specify how to link each transaction belonging to the same query or retrieval request/response. This will depend on each software architecture and is therefore out of scope for IHE to specify. Still, it is essential to link each transaction involved in the same request/response. The underlying standards used in IHE XDS/XCA/XUA has no mechanism to include an identifier which can be added in each transaction a query or retrieval request/response consists of.

HL7 FHIR¹ defines usage of a custom http header for this purpose: "X-Request-Id". This header should be used as follows in document sharing:

1. The system which initiate a query or retrieval for documents (as the actor document consumer in ITI-18 or ITI-43) must generate a unique (UUID) transaction-id and include this in its request as an http header with the format: X-Request-Id: <unique id>
2. Each actor involved in this query or retrieval, must copy this header and include it in their next (linked) transactions.
3. The "X-Request-Id" header must be included in the audit message as an extra entity as defined in chapter 3.5.12.

Initiating application

As mentioned in the previous section, IHE's logging details are only specified for the IHE transactions. Requests consisting of multiple IHE transactions are not described by IHE. Who was the initiating application in a chain of multiple synchronous IHE transactions? IHE XUA specifies elements which holds information about the user and the organization. But this specification does not include any information about the application initiating a query or retrieval of documents. A software application can represent many organizations, and it is important to include information about which application initiated the request, so that an analysis of the audit log can show a system's involvement.

HL7 FHIR defines some custom headers where "X-Forwarded-For" identifies the originating system. To identify the initiating application, document consumers are required to add this header variable. Standard usage of this header variable is to include application identifiers for each application the request visits. Therefore, the value can be chained with multiple identities. The first value shall always be the initiating application. The value used for identification must be the same for each request but can be chosen by each implementor. Each actor must include this header information in the audit log as defined in chapter 3.5.12.

3.3 Duration of each transaction

We recommend that each actor initiating an XCA/XDS transaction should record the duration (in milliseconds) of each transaction. This is useful for evaluate the performance of the different systems.

3.4 Document formats

A document can have different formats: xml, pdf, tiff etc. To show a document to the user a Document Consumer must recognize the format to select a viewer able to understand the format. Combinations of the metadata attributes MimeType and FormatCode shall give enough information for Document Consumers to choose a correct viewer. Examples of valid combinations is shown in chapter 3.4.5 It is recommended to use XML based document formats since these documents are machine readable.

¹ <http://www.hl7.org/fhir/http.html#custom>

3.4.1 XML-based document formats

Several XML-based message standards are mandatory to use in Norway. These standards are published in the reference catalogue at ehelse.no. Documents based on these standards should be shared in xml-formats, and stylesheets for displaying these XML formats are published on Sarepta.ehelse.no.

Example on usage:

Filetype: XML

MimeType: application/xml

FormatCode: urn:no:ehelse:xmlstds:henvisning:2017-11-30

3.4.2 CDA based document formats

CDA is a HL7 standard for static clinical documents. CDA is not used on a national level in Norway today and usage of CDA documents must therefore be avoided. In the future, national usage of CDA based clinical documents will probably need to be supported.

3.4.3 CDA wrapper for non-XML documents:

The CDA standard includes a technique to wrap an XML envelope around non-xml documents to add XML metadata to the document. Such a CDA document consists of a CDA header where metadata is placed and a CDA body where the non-XML document is included.

Wrapping non-XML documents like images, PDFs and RTFs in a CDA wrapper is allowed.

When a CDA wrapper is used for non-XML documents, MimeType shall include the Mime type of the non-XML document and FormatCode shall specify usage of a CDA wrapper with version.

Examples:

Filetype: GIF

MimeType: image/gif

FormatCode: urn:hl7-org:sdwg:ccda-nonXMLBody:2.1

Filetype: PDF

MimeType: application/pdf

FormatCode: urn:hl7-org:sdwg:ccda-nonXMLBody:2.1

Metadata in the CDA header is currently not profiled for use in Norway and it is up to each document repository to decide which metadata to include. IHE has for the profile XDS-SD profiled use of the CDA headers, see chapter 5.2.3 in IHE ITI TF-3.

When displaying non-XML documents, it is common to show some of the document's metadata in the same display. Although metadata is included in the CDA header, we recommend using metadata from the ITI-18 response since these metadata are standardized.

3.4.4 Non-XML documents without CDA wrapper

Document Consumers must also support non-XML documents without CDA wrapper.

When Document repositories return documents, they must use MimeType to specify the format of the non-XML document. For non-XML documents without CDA wrapper, specifying MimeType is sufficient. The FormatCode attribute must still always be filled out according to the Norwegian metadata profile (see chapter 1.4). In such cases "urn:ihe:iti:xds:2017:mimeTypeSufficient" shall be used.

Examples:

Filetype: GIF
 MimeType: image/gif
 FormatCode: urn:ihe:iti:xds:2017:mimeTypeSufficient

Filetype: PDF
 Mime: application/pdf
 FormatCode: urn:ihe:iti:xds:2017:mimeTypeSufficient

3.4.5 Examples of valid combinations of FormatCode and MimeType

The list of combinations in Table 4 shows a few examples. A list of valid combinations is published on Sarepta.ehelse.no.

Table 4 Examples of combination of Formatcode and MimeType

Format	Formatcode	MimeType
RTF document	urn:ihe:iti:xds:2017:mimeTypeSufficient	text/rtf
RTF document with CDA wrapper version 2.1	urn:hl7-org:sdwg:ccda-nonXMLBody:2.1	text/rtf
GIF image	urn:ihe:iti:xds:2017:mimeTypeSufficient	image/gif
GIF image with CDA wrapper v 2.1	urn:hl7-org:sdwg:ccda-nonXMLBody:2.1	image/gif
PDF document	urn:ihe:iti:xds:2017:mimeTypeSufficient	application/pdf
PDF document with CDA wrapper v 2.1	urn:hl7-org:sdwg:ccda-nonXMLBody:2.1	application/pdf
Epikrise 1.2	urn:no:kith.xmlstds:epikrise:2012-02-15	application/xml
Henvising 1.1	urn:no:kith.xmlstds:henvising:2012-02-15	application/xml
Henvising 2.0	urn:no:ehelse.xmlstds:henvising:2017-11-30	application/xml

3.5 Audit logging

Each organization involved in document sharing must follow standard requirements for audit logging. These requirements are described in the Norwegian Code of Conduct for information security and data protection in the healthcare and care services sector (Normen.no). In a distributed environment these requirements should be standardized to provide an opportunity to comparing audit events between organizations. This chapter describes which data elements each organization should include in their audit logging. This should be seen as guidelines for each organization. The purpose of using a common standard of audit events is to ensure later aggregation and/or comparisons of audit events between organizations.

There are many purposes for audit logging. In this document we focus on three objectives of audit logs:

1. Verifiability of health professionals' purpose of accessing health information
2. Disclosure of health information. Who has accessed your health information?
3. Distributed troubleshooting

To fulfill the first objective, it is required that an audit of each transaction is logged and stored in a protected archive. This document describes for each ITI-transaction the requirements for logging.

To fulfill the second objective, the involved organizations must agree upon who will be the source for this purpose. The disclosure audit events must be accessible to the citizen from Helsenorge. These events are intended to be the source to fulfill the patient's right to get information on who has accessed their health information through document sharing. Although many systems and organizations are involved in each transaction, only one organization should be responsible for auditing of this type of event. The sources of health information (Document register or Document repository in the context of document sharing) shall be responsible for audit logging with this purpose.

To fulfill the third objective, it is required that each transaction must be audited for each system involved in a transaction. The purpose of this auditing is to follow the flow of a transaction between the involved systems when incidents occurs.

Detailed description of audit logging when using document sharing is in this document based on IHE ATNA Audit Trail and Node Authentication Profile [IHE ITI TF-2a].

At the present time of writing this guide, IHE is working on a new version of IHE ATNA where they are including support for HL7 FHIR AuditEvent as the message format and http as transport protocol. This supplement (Add RESTful ATNA (Query and Feed)) is now in a trial version (see chapter 1.2).

The use of HL7 FHIR AuditEvent can bridge audit logging of document- and data sharing. This document describes audit logging using the HL7 FHIR AuditEvent message format (version R4). The DICOM based message format may be used provided that it is compatible with the AuditEvent profile of document sharing usage. IHE ATNA will include a normative mapping between AuditEvent and the DICOM based message format.

3.5.1 Consistent time

Consistent Time defines mechanisms to synchronize the time base between multiple actors and computers. National document sharing architecture requires use of a consistent time base on multiple computers. The IHE Consistent Time Profile specifies the use of the Network Time Protocol (NTP) defined in RFC1305.

3.5.2 Actors and transactions in IHE ATNA

In Figure 4 actors and transactions included in IHE ATNA are shown. This guide covers "Record Audit Event [ITI-20]". Each role defined in the IHE XDS, XUA and XCA profiles will also include the role "Secure application" or "Secure Node" and therefore have requirements for generating a "Record Audit Event [ITI-20]" and sending this to an "Audit Record Repository". This repository can be included in the same application as the "Secure application" or it could be an external application. This document will not give any recommendation on this architecture question.

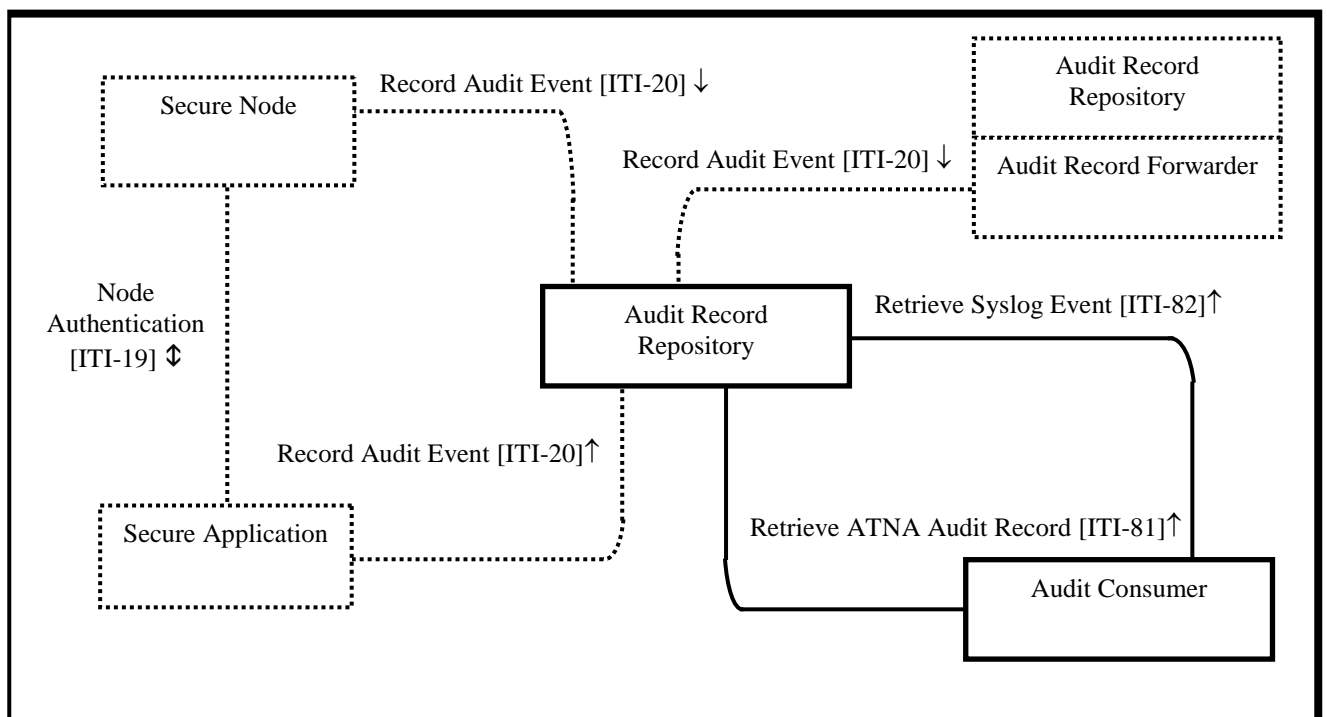

Figure 4 Actors and transactions in IHE ATNA profile

Figure 5 shows an example of audit logging when the ITI-18 transaction is used. The following audit events must be logged for ITI-18 and ITI-38:

1. The Document Consumer who initiate an ITI-18 must log this event.
2. The National Gateway, which is an Initiating Gateway, must log both receiving an ITI-18 transaction and sending an ITI-38 transaction (for each ITI-38 if more than one responding gateway). If a National Document Register is established in the national community, the National Gateway also must send an ITI-18 to this register and this must also be logged by the National Gateway.
3. The responding gateway must log the reception of an ITI-38 and for each ITI-18 request sending to the document registers.

- Each document register must log the reception of an ITI-18. In addition, they must log a Disclosure event if the register had information of the requested patient. The Disclosure event shall be used as the basis of giving the patient information of who has accessed his/her health information.

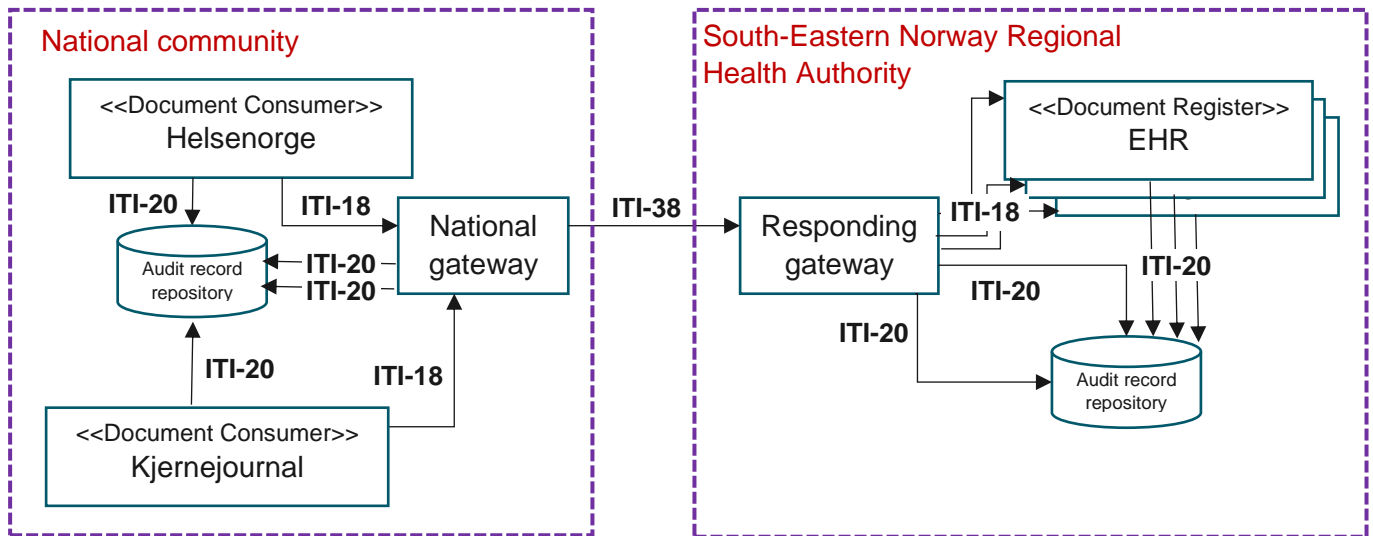

Figure 5 Example showing audit logging for combined ITI-18 and ITI-38 transactions

3.5.3 Message category elements

The message format profiled in IHE ATNA defines the format of the data to be collected and the minimum set of attributes that need to be captured by healthcare application systems for subsequent use by an automation-assisted review application. The data includes records of who accessed healthcare data, when, for what action, from where, and which patients' records were involved.

The standard defines 5 categories that are subject to audit activity as shown in Figure 6

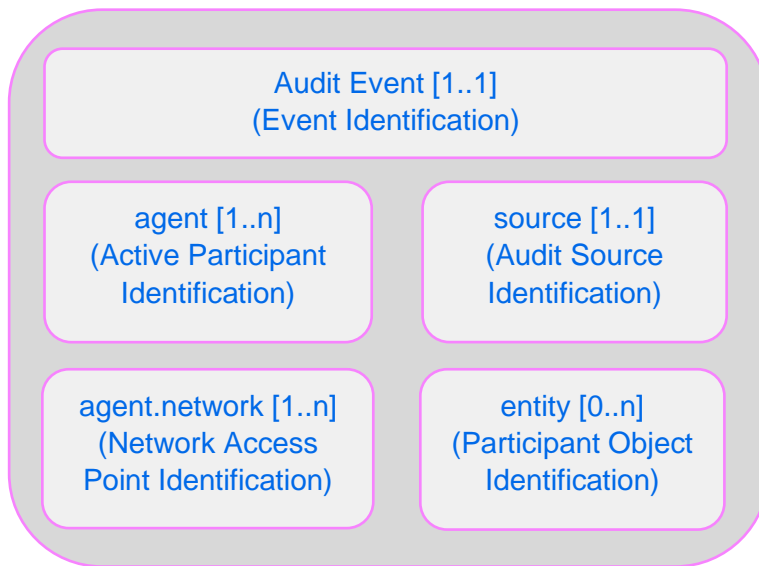

Figure 6 Audit message category elements

These categories are further described in Table 5.

Table 5 Audit message category element descriptions

AuditEvent message category	DICOM message category	Description (from RFC3881)
Audit Event	Event Identification	What was done? <i>“The following data identifies the name, action type, time, and disposition of the audited event. There is only one set of event identification data per audited event”</i>
agent	Active Participant Identification	By whom? <i>“The following data identify a user for the purpose of documenting accountability for the audited event. A user may be a person, or a hardware device or software process for events that are not initiated by a person.”</i>
source	Audit Source Identification	Using which server? <i>“Identifier of the source where the event originated.”</i>
agent.network	Network Access Point Identification	Initiated from where? <i>“The network access point identifies the logical network location for application activity. These data are paired 1:1 with the Active Participant Identification data.”</i>
entity	Participant Object Identification	To what resource (patient, record, etc.)? <i>“The following data assist the auditing process by indicating specific instances of data or objects that have been accessed.”</i>

3.5.4 Audit logging in XDS/XCA

The usage of AuditEvent must be profiled for each event context. Each AuditEvent category must be mapped to objects relevant for the event context. For XDS and XCA, IHE has profiled this and this is included in the ITI framework, see for instance ITI TF-2a chapter 3.18.5.1.1 "Document Consumer audit message". In Table 6 the usage of the categories in XDS and XCA are described.

Table 6 Description of AuditEvent categories

AuditEvent message category	DICOM message category	XDS/XCA objects	Description
Audit Event	Event	Event	Audit event according to the XDS/XCA transaction
agent	Active Participant	Source	For queries ITI-18 and ITI-38 the source is the agent that trigger the event. For document retrievals the source is the agent that return the document(s)
		Destination	For queries the destination is the agent that receives the query. For document retrievals the destination is the agent that receives the document(s)
		Human Requestor	The logged in user who triggered the event
source	Audit Source	Audit Source	Legal entity that ensures the uniqueness of the identifiers that are used to identify active participants
entity	Participant Object	Patient	Patient whose data is affected from the event
		Query Parameters	Only used for queries. Shall include the search parameters in the query.
		Document	Only used for document retrievals. Shall include the document_id of the requested document(s)

In this table the following objects are described: Event, Source, Destination, Human Requestor, Audit Source, Patient, Query Parameters and Document. These general objects must be further customized for specific usage. For each XDS and XCA transaction this is done by IHE and can be found in ITI TF-2b (see chapter 1.4). For Norwegian usage this must be further customized.

Detailed descriptions of each object with required/mandatory (M) and optional (O) data elements are described in the next chapters.

Note on examples

For each element an example is shown. All examples are based on the following examples:

Converted ATNA message from a PIX query: <https://www.hl7.org/fhir/audit-event-example-pixQuery.xml.html>

Accounting of a Disclosure: <https://www.hl7.org/fhir/auditevent-example-disclosure.xml.html>

Switzerland: CH:ATC: Document retrieval of radiology report from Regula Fischer
20.10.2020 14:29 on behalf of Dr. med. Hans Allzeitbereit, Member of group Labor 1
Bertaspital, Emergency Access: <http://build.fhir.org/ig/ahdis/ch-atc/AuditEvent-atc-doc-read-ass-hpc.xml.html>

Each example is adapted to Norwegian usage. All examples are informative and are not based on real implementation (in lack of real examples).

3.5.5 Event

This is the audit event according to the XDS/XCA transaction.

Only required or optional elements are showed. Other elements shall not be used.

AuditEvent	DICOM	Opt.	Datatype	Value Constraints	Example
type	EventID	M	Coding	The identifier for the family of event. Identifier for a specific audited event. Is specified for each IHE transaction.	<pre><type> <system value="http://dicom.nema.org/resources/ontology/DICOM"/> <code value="110112"/> <display value="Query"/> </type></pre>
subtype	EventTypeCode	M	Coding	Identifier for the category of event. The specific type(s) within the family applicable to the event. Is uniquely specified for each IHE transaction. OID nr 1.3.6.1.4.1.19376.1.2 is the IHE ITI domain owned and managed by ITI.	<pre><subtype> <system value="urn:oid:1.3.6.1.4.1.19376.1.2"/> <code value="ITI-18"/> <display value="Registry Stored Query"/> </subtype></pre>
action	EventActionCode	M	code	Indicator for type of action performed during the event that generated the audit. C= Create R= Read U= Update D= Delete E= Execute	<pre><action value="E"/></pre>
recorded	EventDateTime	M	instant	The time at which the audited event occurred. An instant in time in the format YYYY-MM-	<pre><recorded value="2015-08-26T23:42:24Z"/></pre>

AuditEvent	DICOM	Opt.	Datatype	Value Constraints	Example
				DDThh:mm:ss.sss+zz:zz. Universal coordinated time (UTC), i.e., a date/time specification that is unambiguous as to local time zones	
purposeOfEvent	PurposeOfUse	O	CodeableConcept	The Purpose Of Use is included to enable some forms of reporting of Accounting of Disclosures and Breach Notification. The PurposeOfEvent value will come from a Value Set defined for use in the XUA based SAML token and hence the value should come from the SAML token. (NB: agent.purposeOfUse is not used by IHE's profile)	<pre> <purposeOfEvent> <coding> <system value="1.0.14265.1"/> <code value="1"/> <display value=" Clinical care provision to an individual subject of care"/> </coding> <text value="ISO 14265 Classification of Purposes for processing personal health information "/> </purposeOfEvent> </pre>
outcome	EventOutcomeIndicator	M	code	Indicates whether the event succeeded or failed. MUST be "0" on full success, "1" in case of a partial delivery, "4" for temporal or recoverable failures, and "8" for permanent failures	<pre> <outcome value="0"/> </pre>

3.5.6 Human requestor (agent)

The logged in user who triggered the event.

AuditEvent	DICOM (ActiveParticipant)	Opt.	Datatype	Value Constraints	Example
agent.type	RoleIDCode	R	Codeable Concept	Specification of the participation type the user plays when performing the event. For health professionals the value set 9060 for volven.no shall be used. For patient or a person representing the patient the HL7 value set "extra-security-role-type" shall be used.	<pre><!--The Human using the software, if known --> <type> <coding> <system value="http://terminology.hl7.org/CodeSystem/extra-security-role-type"/> <code value="humanuser"/> <display value="human user"/> </coding> </type></pre>
agent.who	UserID	M	Identifier	Unique identifier for the user actively participating in the event. The User ID shall tie an audit event to a specific identifier of the User. NameID from the XUA token can be used as a source	<pre><who> <identifier> <system value="urn:oid:2.16.578.1.12.4.1.4.2"/> <value value="13116900216"/> </identifier> </who></pre>
agent.altId	AlternativeUserID	O	string	Alternative User ID shall be the identifier used for that person within an enterprise for authentication purposes, for example, a Kerberos Username (user@realm).	<pre><altId value="601847123"/></pre>
agent.name	UserName	O	string	Person's name	<pre><name value="Line Linedanser"/></pre>

agent.requestor	UserIsRequestor	O	boolean	Indicator that the user is or is not the requestor, or initiator, for the event being audited.	<code><requestor value="true"/></code>
-----------------	-----------------	---	---------	--	--

3.5.7 Source and Destination (agent)

For queries (ITI-18 and ITI-38) the source is the agent that trigger the event and the destination is the agent that receives the query.

For document retrievals the source is the agent that returns the document(s) and the destination is the agent that receives the document(s).

AuditEvent	DICOM (ActiveParticipant)	Opt.	Datatype	Value Constraints	Example
agent.type	RoleIDCode	M	Codeable Concept	Specification of the role(s) the actor plays when performing the event. This is specified by IHE for XDS/XCA: EV(110153, DCM, "Source") for source and EV(110152, DCM, "Destination") for destination	<pre> <type> <coding> <system value="http://dicom.nema.org/resources/ontology/DCM"/> <code value="110153"/> <display value="Source"/> </coding> </type> </pre>
agent.who	UserID	M	Identifier	Unique identifier for the system actively participating in the event. The ID shall tie an audit event to a specific identifier of the actor.	<pre> <who> <identifier> <system value="urn:oid:2.16.578.1.12.4.1.4.101"/> <value value="915933149"/> </identifier> </who> </pre>
agent.altId	AlternativeUserID	O	string	Alternative unique identifier for the source or destination.	<code><altId value="6580"/></code>

AuditEvent	DICOM (ActiveParticipant)	Opt.	Datatype	Value Constraints	Example
agent.name	UserName	O	string	A human readable identification of the source or destination. Process or application name.	<code><name value="Helsenorge portal"/></code>
agent.requestor	UserIsRequestor	O	boolean	Indicator that the user is or is not the requestor, or initiator, for the event being audited. Used to identify which of the participants initiated the transaction being audited. If the audit source cannot determine which of the participants is the requestor, then the field shall be present with the value FALSE in all participants. The system shall not identify multiple participants as UserIsRequestor. If there are several known requestors, the reporting system shall pick only one as UserIsRequestor.	<code><requestor value="false"/></code>
agent.network.address agent.network.type	NetworkAccessPointID NetworkAccessPointTypeCode	M	string code	An identifier for the network access point of the user device This could be a device id, IP address, or some other identifier associated with a device. The type indicates type of network access point: 1= Machine Name, including DNS name 2= IP Address 3= Telephone Number	<code><network> <address value="www.helsenorge.no"/> <type value="1"/> </network></code>

AuditEvent	DICOM (ActiveParticipant)	Opt.	Datatype	Value Constraints	Example
				4= Email address 5= URI (user directory, HTTP-PUT, ftp, etc.)	

3.5.8 Audit Source (source)

The system reporting the event.

AuditEvent	DICOM (AuditSourceIdentification)	Opt.	Datatype	Value Constraints	Example									
source.observer	AuditSourceID	O	Reference	Identifies the authority that is legally responsible for the audit source.	<pre><observer> <reference value=http://nhn.no/> <type value="Organization"/> <display value="Norsk Helsenett"/> </observer></pre>									
source.site	AuditEnterpriseSiteID	O	string	Logical source location within the healthcare enterprise network. For example, a hospital or other provider location within a multi-entity provider group.	<pre><site value="location X"/></pre>									
source.type	AuditSourceTypeCode	O	Coding	The allowed types are: <table border="1" data-bbox="1182 1129 1644 1362"> <thead> <tr> <th>Code</th> <th>Display</th> <th>Definition</th> </tr> </thead> <tbody> <tr> <td><u>1</u></td> <td>User Device</td> <td>End-user display device, diagnostic device.</td> </tr> <tr> <td><u>2</u></td> <td>Data Interface</td> <td>Data acquisition device or instrument.</td> </tr> </tbody> </table>	Code	Display	Definition	<u>1</u>	User Device	End-user display device, diagnostic device.	<u>2</u>	Data Interface	Data acquisition device or instrument.	<pre><type> <system value="http://terminology.hl7.org/CodeSystem/security-source-type"/> <code value="4"/> <display value="Application Server"/> </type></pre>
Code	Display	Definition												
<u>1</u>	User Device	End-user display device, diagnostic device.												
<u>2</u>	Data Interface	Data acquisition device or instrument.												

				<u>3</u>	Web Server	Web Server process or thread.
				<u>4</u>	Application Server	Application Server process or thread.
				<u>5</u>	Database Server	Database Server process or thread.
				<u>6</u>	Security Server	Security server, e.g. a domain controller.
				<u>7</u>	Network Device	ISO level 1-3 network component.
				<u>8</u>	Network Router	ISO level 4-6 operating software.
				<u>9</u>	Other	Other kind of device (defined by DICOM, but some other code/system can be used)

3.5.9 Patient (entity)

Which patient has been accessed? For all transactions the audit event shall include the patient whose data is affected from the event.

AuditEvent	DICOM (Participant ObjectIdentification)	Opt.	Datatype	Value Constraints	Example
entity.what	ParticipantObjectID and ParticipantObjectIDTypeCode	M	Reference	The patient ID in HL7 CX format. The patient identifier attribute in the XUA token, resource-id, can be used here.	<pre> <what> <identifier> <value value="29019900248^^^&2.16.578.1.12.4.1.4.1&mp;ISO"/> </identifier> </what> </pre>
entity.type	ParticipantObjectTypeCode	M	Coding	IHE specified: "1" (Person)	<pre> <type> <system value="http://terminology.hl7.org/CodeSystem/audit-entity-type"/> <code value="1"/> <display value="Person"/> </type> </pre>
entity.role	ParticipantObjectTypeCodeRole	M	Coding	IHE specified: "1" (Patient)	<pre> <role> <system value="http://terminology.hl7.org/CodeSystem/object-role"/> <code value="1"/> <display value="Patient"/> </role> </pre>

3.5.10 Query Parameters (entity)

What has been accessed? For queries the audit event shall include the search parameters in the query.

AuditEvent	DICOM (Participant ObjectIdentification)	Opt.	Datatype	Value Constraints	Example
entity.what	ParticipantObjectID and ParticipantObjectIDTypeCode	M	Reference	Stored Query ID (UUID) + EV("ITI-18", "IHE Transactions", "Registry Stored Query")	<pre> <what> <Reference value="urn:uuid:14d4d ebf-8f97-4251-9a74-a90016b0af0d" /> <coding> <system value="IHE transactio ns"/> <code value="ITI-18"/> <display value="Registry Store d Query"/> </coding> </what> </pre>
entity.type	ParticipantObjectTypeCode	M	Coding	"2" (system object)	<pre> <type> <system value="http://terminolo gy.hl7.org/CodeSystem/audit-enti ty-type"/> <code value="2"/> <display value="System Object"/> </type> </pre>
entity.role	ParticipantObjectTypeCodeRole	M	Coding	"24" (query)	<pre> <role> <system value="http://terminol ogy.hl7.org/CodeSystem/object-ro le"/> <code value="24"/> </pre>

AuditEvent	DICOM (Participant ObjectIdentification)	Opt.	Datatype	Value Constraints	Example
					<pre><display value="Query" /> </role></pre>
entity.query	ParticipantObjectQuery	M	base64Binary	the AdhocQueryRequest, base64 encoded.	<pre><query value=" PG5zNDpBZGhvY1F1ZXJ5 UmVxdWVzdCB4bWxuczpuczY9InVybjpvYXNpc zpuYW1lc2p0YzplYnhtbClzZWdyZXA6eHNkOm xjbTozLjAiIHhtbG5zOm5zNT0idXJuOmloZTp pdGk6eGRzLWI6MjAwNyIgeG1sbnM6bnM0PSJl cm46b2FzaXM6bmFtZXM6dGM6ZWJ4bWwtcmVnc mVwOnhzZDpxdWVyeTozLjAiIHhtbG5zOm5zMz 0idXJuOm9hc2lzM5hbWVzOnRjOmVieG1sLXJ lZ3JlcDp4c2Q6cnM6My4wIiB4bWxuczpuczI9 InVybjpvYXNpczpuYW1lc2p0YzplYnhtbClzZ WdyZXA6eHNkOnJpbTozLjAiPjxuczQ6UmVzcG 9uc2VFcHRpb24gcmV0dXJuVHlwZT0iT2JqZWNN 0UmVmIiByZXR1cm5Db2lwb3NlZE9iamVjdHM9 InRydWUiLz48bnMyOkFkaG9jUXVlcnkgaWQ9I nVybjp1dWlkOjE0ZDRkZWJmLThmOTctNDI1MS 05YTc0LWE5MDAxNmIwYyYwZCI+PG5zMjpTbG9 0IG5hbWU9IiRyRFNeb2N1bWVudEVudHJ5Q29u ZmlkZW50aWFsaXR5Q29kZSI+PG5zMjpWYX1Z Uxpc3Q+PG5zMjpWYX1ZT4oJ0xeXjIuMTYuOD QwLjEuMTEzODgzLjUuMjUnKTwwbnMyO1ZhbHV lPjxuczI6VmFsdWU+KcDnX14yLjE2Ljg0MC4x LjExMzg4My41LjI1Jyk8L25zMjpWYX1ZT48b nMyO1ZhbHVlPignT15eMi4xNi44NDAuMS4xMT M4ODMuNS4yNScpPC9uczI6VmFsdWU+PG5zMjp WYX1ZT4oJ1VeXjIuMTYuODQwLjEuMTEzODgz LjUuMjUnKTwwbnMyO1ZhbHVlPjxuczI6VmFsd WU+KcDnX14yLjE2Ljg0MC4xLjExMzg4My41Lj I1Jyk8L25zMjpWYX1ZT48L25zMjpWYX1ZUx pc3Q+PC9uczI6U2xvdD48bnMyO1Nsb3QgZmFt ZT0iJFhEU0RvY3VtZW50RW50cnlQYXRpZW50S WQiPjxuczI6VmFsdWVMaXN0PjxuczI6VmFsdW U+JzEyMTE5MDAwNDY1X15eJmFtcDsyLjE2LjU 3OC4xLjEyLjQuMS40LjEmYW1wO0lTTyc8L25z MjpWYX1ZT48L25zMjpWYX1ZUxpc3Q+PC9ucz I6U2xvdD48bnMyO1Nsb3QgZmFtZT0iJFhEU0 RvY3VtZW50RW50cnlTdGF0dXMiPjxuczI6VmF sdWVMaXN0PjxuczI6VmFsdWU+KcDlcm46b2Fz aXM6bmFtZXM6dGM6ZWJ4bWwtcmVncmVwO1N0Y XR1c1R5cGU6QXBwcm92ZWQnKTwwbnMyO1ZhbH VlPjwwbnMyO1ZhbHVlTG1zdD48L25zMjpTbG9</pre>

AuditEvent	DICOM (Participant ObjectIdentification)	Opt.	Datatype	Value Constraints	Example
					<pre>0PjwvbnMyOkFkaG9jUXV1cnk+PC9uczQ6QWRo b2NRdWVyeVJ1cXV1c3Q+"/> </pre>
<p>entity.detail</p> <p>entity.detail.type</p> <p>entity.detail.ValueBase64Binary</p>	<p>ParticipantObjectDetail</p> <p>ParticipantObjectDetail@type</p> <p>ParticipantObjectDetail@value</p>	U	String string or base64B inary	<p>The ParticipantObjectDetail element may occur more than once. In one element, set “QueryEncoding” as the value of the attribute type, Set the attribute value to the character encoding, such as “UTF-8”, used to encode the ParticipantObjectQuery before base64 encoding. In another element, set “urn:ihe:iti:xca:2010:homeCommunityId” as the value of the attribute type and the value of the homeCommunityID as the value of the attribute value, if known.</p>	<pre><detail> <type value="QueryEncoding" /> <valueBase64Binary value="d2lu ZG93cy0xMjUy" /> </detail> <detail> <type value="Repository Unique Id" /> <valueBase64Binary value="Mi4x Ni44NDAuMS4xMTM4ODMuMi45LjIuODQy MTAxLjQuNS4zLjE=" /> </detail></pre>

3.5.11 Document (entity)

What has been accessed? This object is only used for document retrieval audit events. Audit events must include the document_id(s) of the requested document(s)

AuditEvent	DICOM (Participant ObjectIdentification)	Opt.	Datatype	Value Constraints	Example
entity.what	ParticipantObjectID and ParticipantObjectTypeCode	M	Reference	The value of <ihe:DocumentUniqueId/>	<pre> <what> <identifier> <type> <coding> <system value="urn:uid:2e82c1f6-a085-4c72-9da3-8640a32e42ab"/> <code value="IHE XDS Metadata"/> <display value="XDS DocumentEntry.uniqueId"/> </coding> </type> <system value="urn:ietf:rfc:3986"/> <value value="urn:oid:1.2.3.4.5"/> </identifier> </what> </pre>
entity.type	ParticipantObjectTypeCode	M	Coding	IHE specific: "2" (System)	<pre> <type> <system value="http://terminology.hl7.org/CodeSystem/audit-entity-type"/> <code value="2"/> <display value="System Object"/> </type> </pre>

AuditEvent	DICOM (Participant ObjectIdentification)	Opt.	Datatype	Value Constraints	Example
entity.role	ParticipantObjectTypeCodeRole	M	Coding	IHE specific: "3" (report)	<pre> <role> <system value="http://terminology.hl7.org/CodeSystem/object-role"/> <code value="3"/> <display value="Report"/> </role> </pre>
entity.detail entity.detail.type entity.detail. ValueBase64Binary	ParticipantObjectDetail ParticipantObjectDetail@type ParticipantObjectDetail@value	U		The ParticipantObjectDetail element may occur more than once. In one element, the value of in value attribute, "Repository Unique Id" in type attribute In another element, the value of "ihe:homeCommunityID" as the value of the attribute type and the value of the homeCommunityID as the value of the attribute value	<pre> <!-- base64 of OID eg 1.2.3 == --> <detail> <type value="Repository Unique Id"/> <value value="MS4yLjM=" /> </detail> <!-- base64 of OID URN homeCommunityId e.g. 5.6.7.8 --> <detail> <type value="homeCommunityID"/> <value value="NS42Ljc u0A=" /> </detail> <!-- base64 typeCode 44 4561001 --> <detail> <type value="EprDocumentTypeCode"/> <value value="NDQ0NTY xMDAx" /> </detail> </pre>

3.5.12 Transaction-id and initiating application (entity)

The usage of http header variables "X-Request-Id" and "X-Forwarded-For" are described in chapter 3.2.1. "X-Request-Id" is the source for audit of the transaction-id and the first value in "X-Forwarded-For" is the source for auditing an identification of the initiating application. These two information elements are expected to be added to ALL audit messages defined in this document.

AuditEvent	DICOM (Participant ObjectIdentification)	Opt.	Datatype	Value Constraints	Example
entity.what	ParticipantObjectID and ParticipantObjectIDTypeCode	M	Reference	The transaction-id generated by the initiating application. Source is the http header "X-Request-Id"	<pre><what> <identifier> <value value="urn:uuid:2e82c1f6-a085-4c72-9da3-8640a32e42ab"/> </identifier> </what></pre>
entity.type	ParticipantObjectTypeCode	M	Coding	IHE specified: "4" (Other)	<pre><type> <system value="http://terminology.hl7.org/CodeSystem/audit-entity-type"/> <code value="4"/> <display value="Other"/> </type></pre>
entity.role	ParticipantObjectTypeCodeRole	M	Coding	IHE specified: "21" (Job Stream)	<pre><role> <system value="http://terminology.hl7.org/CodeSystem/object-role"/> <code value="21"/> <display value="Job Stream"/> </role></pre>
entity.detail	ParticipantObjectDetail	M		Who was the initiating application for this query or retrieval request? Source is "X-	<pre><detail> <type value="Initiating Application Id"/></pre>

AuditEvent	DICOM (Participant ObjectIdentification)	Opt.	Datatype	Value Constraints	Example
entity.detail.type	ParticipantObjectDetail@type ParticipantObjectDetail@value			Forwarded-For" and the type of the value must be decided by the implementors of the initiating application	<pre><value value="10:20:1034:121"/> </detail> </detail></pre>
entity.what	ParticipantObjectID	M	Reference		<pre><what> <identifier> <value value="urn:uuid:2e82c1f6-a085-4c72-9da3-8640a32e42ab"/> </identifier> </what></pre>
entity.type	ParticipantObjectTypeCode	M	Coding		<pre><type> <code value="X-Request-Id"/> </type></pre>

3.5.13 Accounting of disclosure

In the introduction of chapter 3.5 we described different purposes audit events must fulfill. One of these purposes is to give access to the patient: who has accessed his/her health information. This purpose is called accounting of disclosure. The audit message for this event must be customized to be understandable for the patient.

Although many systems are involved in a retrieval of a document only one actor should audit this event. In Norwegian legislation the Data Controller must be responsible for this event. In a document sharing context this means that the Data controllers of Document Register and Document Repositories must fulfill requirements for accounting of disclosure. In addition, they must expose an API to Helsenorge.no to make available the accounting of disclosure to the patient.

In IHE ITI TF Volume 2a, requirements for accounting are described under ITI-20 transaction (chapter 3.20.9). The requirements of an accounting of disclosures are based on ASTM-2147 (Standard Specification for Audit and Disclosure Logs for Use in Health Information Systems). A disclosure shall include the following, when the value is known:

- Who did the disclosure? This is the user described in the XUA based SAML token. In the standard defined as the releasing agent.
- When did the disclosure happen?
- Who was the data disclosed to? This is usually the receiving agent machine and other parties, if known.
- What patient was involved (multiple patients would be done as multiple audit entries),
- What data was involved. For document sharing this is either the metadata about a document or the document itself.
- Why the disclosure was done. Normally described in the purpose of use field in the SAML token.
- What system detected this disclosure? (Audit Source)

There is some other information that may be available:

- Who is the custodian of the data (the official organization responsible)?
- Who authorized the release such as a guardian or relative (authorizing agent)?

According to the Norwegian target architecture for document sharing an accounting of disclosure must include:

<Person name (with role and id)> from <organization, organization unit> has in the period: <period> gained access to the document <document title> of the type <document type> with the purpose <purpose of use> from <releasing organization>

In Table 7 objects that must be included in an accounting of disclosure event are shown.

Table 7 Objects that must be included in an accounting of disclosure event

AuditEvent message category	DICOM message category	Accounting of disclosure objects	Description
Audit Event	Event	Event	Accounting of disclosure Audit event
agent	Active Participant	Releasing agent	The agent that has the document stored and disclosed it.
		Receiving agent	The agent(s) that received the document. Normally two agents: a user (logged in user) and a system (document consumer).
		Custodian	The official organization that is the custodian of the documents released (used only if the releasing agent is different from the custodian agent)
		Authorizing agent	Who authorized the release? For health professionals logged in to Kjernejournal, Kjernejournal should be the authorizing agent.
source	Audit Source	Audit Source	Legal entity that ensures the uniqueness of the identifiers that are used to identify active participants (agents)
entity	Participant Object	Patient	Patient whose data is disclosed
		Document	Shall include the document_id and title of the disclosed document(s)

class Accounting of disclosure

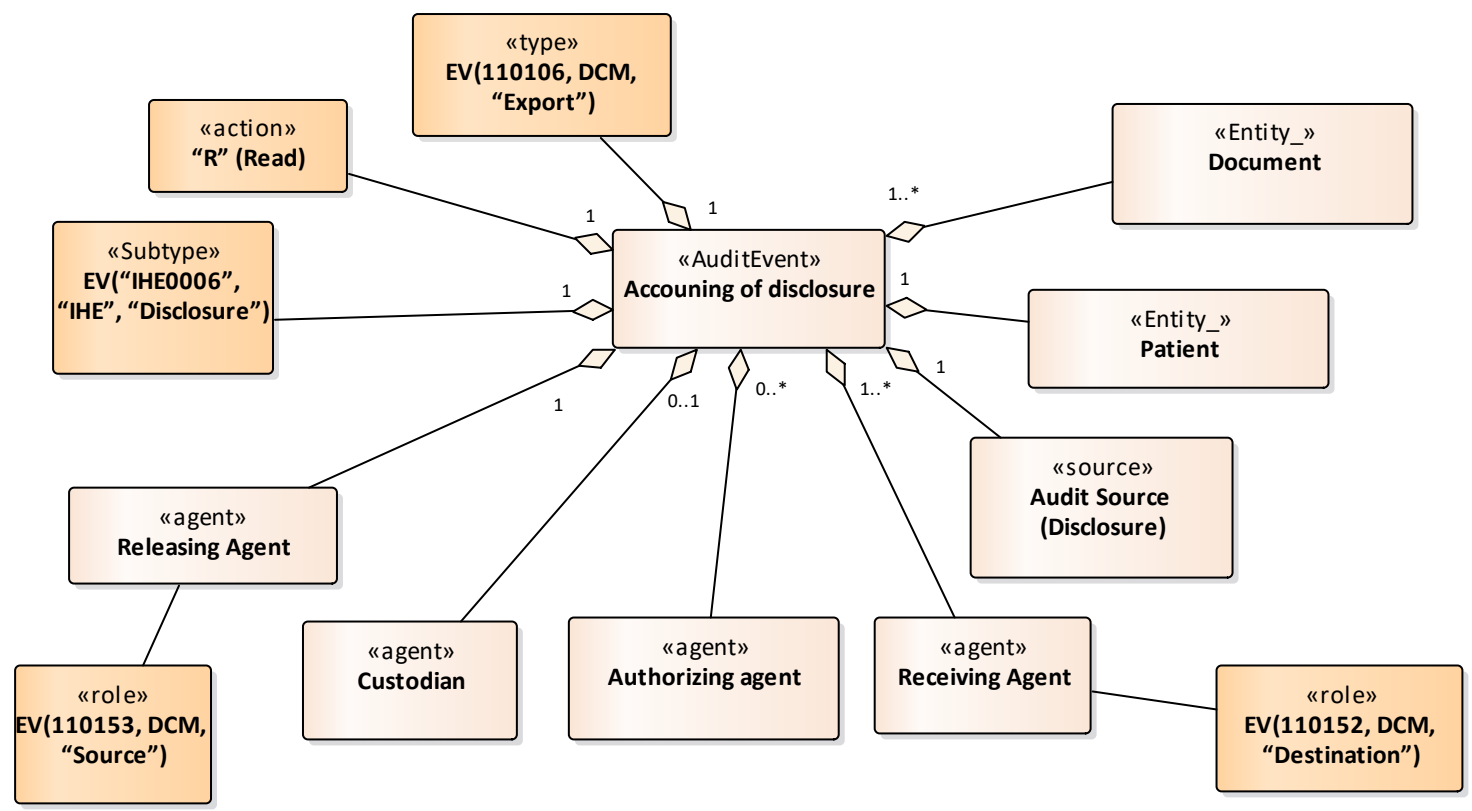

3.5.13.1 Event (mandatory)

AuditEvent	DICOM	Opt.	Datatype	Value Constraints	Example
type	EventID	M	Coding	EV(110106, DCM, "Export")	<pre><type> <system value="http://dicom .nema.org/resources/ontology/D CM"/> <code value="110106"/> <display value="Export"/> </type></pre>
subtype	EventTypeCode	M	Coding	Identifier for the category of event. Value shall be as shown in the example.	<pre><subtype> <system value="urn:oid:1.3. 6.1.4.1.19376.1.2"/> <code value="IHE0006"/> <display value="Disclosure"/ > </subtype></pre>
action	EventActionCode	M	code	Indicator for type of action performed during the event that generated the audit. C= Create R= Read U= Update D= Delete E= Execute	<pre><action value="E"/></pre>
recorded	EventDateTime	M	instant	The time at which the audited event occurred. An instant in time in the format YYYY-MM-DDThh:mm:ss.sss+zz:zz. Universal coordinated time (UTC), i.e., a date/time specification that is unambiguous as to local time zones	<pre><recorded value="2015-08-26T23 :42:24Z"/></pre>

AuditEvent	DICOM	Opt.	Datatype	Value Constraints	Example
purposeOfEvent	PurposeOfUse	O	CodeableConcept	The Purpose of use should be included to enable some form of reporting of Accounting of Disclosures and Breach Notification. The PurposeOfEvent value will come from a Value Set defined for use in the XUA based SAML token and hence the value should come from the SAML token.	<pre> <purposeOfEvent> <coding> <system value="1.0.14265.1"/> <code value="1"/> <display value=" Clinical care provision to an individual subject of care"/> </coding> <text value="ISO 14265 Classification of Purposes for processing personal health information "/> </purposeOfEvent> </pre>
outcome	EventOutcomeIndicator	M	code	Indicates whether the event succeeded or failed. MUST be "0" on full success, "1" in case of a partial delivery, "4" for temporal or recoverable failures, and "8" for permanent failures	<pre> <outcome value="0"/> </pre>

3.5.13.2 Releasing Agent (mandatory)

The agent that released the documents. This is the Organization that holds the data. If this Organization is not the Custodian of this data, the Custodian agent must be used.

AuditEvent	DICOM (ActiveParticipant)	Opt.	Datatype	Value Constraints	Example
agent.type	RoleIDCode	M	Codeable Concept	Specification of the role(s) the actor plays when performing the event. Must indicate that this agent is the source of the Disclosure event Predefined value from IHE.	<pre><type> <coding> <system value="http://dicom.nema.org/resources/ontology/DCM"/> <code value="110153"/> <display value="Source"/> </coding> </type></pre>
agent.who	UserID	M	Reference	Unique identifier of the organization releasing the data. The ID shall tie the disclosure to a specific identifier of the actor - for instance a Norwegian organization ID issued by "Brønnøysundregistrene"	<pre><who> <identifier> <system value="urn:oid:2.16.578.1.12.4.1.4.101"/> <value value="123456789"/> </identifier> </who></pre>
agent.altId	AlternativeUserID	O	string	Alternative unique identifier of the releasing agent. Could be HER-id or RESH-id	<pre><altId value="6580"/></pre>
agent.name	UserName	M	string	A human readable identification of the releasing agent. Organization or organization unit name.	<pre><name value="helseforetak x"/></pre>
agent.requestor	UserIsRequestor	O	boolean	Indicate if the agent is or is not the requestor, or initiator, for the disclosure. Shall be false for releasing agent.	<pre><requestor value="false"/></pre>

3.5.13.3 Receiving Agent (mandatory) – the logged in user

The receiving agent is the human user (logged in) who received the document

AuditEvent	DICOM (ActiveParticipant)	Opt.	Datatype	Value Constraints	Example
agent.type	RoleIDCode	M	Codeable Concept	Must indicate that this agent is the source of the Disclosure event. Predefined value.	<pre> <type> <coding> <system value="http://dicom.nema.org/resources/ontology/DCM"/> <code value="110152"/> <display value="Destination" /> </coding> </type> </pre>
agent.who	UserID	M	Identifier	Identity of the human that initiated the disclosure of the patient's health records. The User ID shall tie the audit event of the disclosure to a specific identifier of the User. NameID from the XUA token can be used as a source	<pre> <who> <identifier> <system value="urn:oid:2.16.578.1.12.4.1.4.2"/> <value value="13116900216"/> </identifier> </who> </pre>
agent.altId	AlternativeUserID	O	string	Alternative User ID must be the HPR ID if the receiving agent is a health professional.	<pre> <altId value="601847123"/> </pre>
agent.name	UserName	M	string	Person's name	<pre> <name value="Line Linedanser"/> </pre>
agent.requestor	UserIsRequestor	M	boolean	Must specify if the user is the requestor, or initiator, of the disclosure event being audited.	<pre> <requestor value="true"/> </pre>

3.5.13.4 Receiving Agent (mandatory) – organization

Shall describe the organization where the logged in health professional who triggered the disclosure is employed.

AuditEvent	DICOM (ActiveParticipant)	Opt.	Datatype	Value Constraints	Example
agent.type	RoleIDCode	M	Codeable Concept	Specification of the role(s) the actor plays when performing the event. Must indicate that this agent is the source of the Disclosure event Predefined value from IHE.	<pre> <type> <coding> <system value="http://dicom.nema.org/resources/ontology/DCM"/> <code value="110152"/> <display value="Destination" /> </coding> </type> </pre>
agent.who	UserID	M	Reference	Unique identifier of the organization releasing the data. The ID shall tie the disclosure to a specific identifier of the actor - for instance a Norwegian organization ID issued by "Brønnøysundregistrene"	<pre> <who> <identifier> <system value="urn:oid:2.16.578.1.12.4.1.4.101"/> <value value="012345678"/> </identifier> </who> </pre>
agent.altId	AlternativeUserID	O	string	Alternative unique identifier of the releasing agent. Could be HER-id or RESH-id	<pre> <altId value="6580"/> </pre>
agent.name	UserName	M	string	A human readable identification of the releasing agent. Organization or organization unit name.	<pre> <name value="Legerkontor y"/> </pre>
agent.requestor	UserIsRequestor	O	boolean	Indicator that the agent is or is not the requestor, or initiator, for the disclosure. Shall be false for releasing agent.	<pre> <requestor value="false"/> </pre>

3.5.13.5 Custodian (optional)

If the releasing agent is not the same agent as the custodian of the document, this object can be used. For instance, if the releasing agent is a "data processor" (In Norwegian: "databehandler") this object should be used to include the "data controller" (In Norwegian: "dataansvarlig").

The specification is the same as for the Releasing agent.

3.5.13.6 Authorizing Agent (optional)

Who authorized the release? For health professionals logged in to Kjernejournal, Kjernejournal should be the authorizing agent.

3.5.13.7 Audit Source (mandatory)

Same as chapter 3.5.8

3.5.13.8 Patient

Same as chapter 3.5.9.

3.5.13.9 Document

Same as chapter 3.5.11.

3.6 ITI-18 Registry Stored Query

ITI-18 Registry Stored Query transaction is a query done by either Document Consumer or XCA gateway against Document Registry to find documents with defined criteria.

Example:

```
<ns4:AdhocQueryRequest xmlns:ns4="urn:oasis:names:tc:ebxml-regrep:xsd:query:3.0"
  xmlns:ns2="urn:oasis:names:tc:ebxml-regrep:xsd:rim:3.0">
  <ns4:ResponseOption returnType="LeafClass" returnComposedObjects="true"/>
  <ns2:AdhocQuery id="urn:uuid:14d4debf-8f97-4251-9a74-a90016b0af0d">
    <ns2:Slot name="$XDSDocumentEntryConfidentialityCode">
      <ns2:ValueList>
        <ns2:Value>('L'^2.16.840.1.113883.5.25')</ns2:Value>
        <ns2:Value>('M'^2.16.840.1.113883.5.25')</ns2:Value>
        <ns2:Value>('N'^2.16.840.1.113883.5.25')</ns2:Value>
        <ns2:Value>('R'^2.16.840.1.113883.5.25')</ns2:Value>
        <ns2:Value>('U'^2.16.840.1.113883.5.25')</ns2:Value>
      </ns2:ValueList>
    </ns2:Slot>
    <ns2:Slot name="$XDSDocumentEntryPatientId">
      <ns2:ValueList>
        <ns2:Value>'13116900217^^^&amp;2.16.578.1.12.4.1.4.1&amp;ISO'</ns2:Value>
      </ns2:ValueList>
    </ns2:Slot>
    <ns2:Slot name="$XDSDocumentEntryStatus">
      <ns2:ValueList>
        <ns2:Value>('urn:oasis:names:tc:ebxml-regrep:StatusType:Approved')</ns2:Value>
      </ns2:ValueList>
    </ns2:Slot>
  </ns2:AdhocQuery>
</ns4:AdhocQueryRequest>
```

ITI-18 specifies many different types of stored queries. For national use of ITI-18 only two stored queries are required to support for Document Consumers and XCA gateways:

- FindDocuments: Find documents in a document registry for a given patientID with a matching availabilityStatus attribute
- GetDocuments: Retrieve metadata on (a collection of) documents given unique Ids on the documents.

Other stored queries defined in 3.18.4.1.2.3.7 in ITI TF-2a is optional and XCA communities not supporting these stored queries shall return a zero successful result.

3.6.1 Parameters for stored query FindDocuments

ITI TF-2a specifies the query parameters for a stored query “FindDocuments” (see ITI TF-2a 3.18.4.1.2.3.7.1). The stored query “FindDocuments” MUST be used using the parameters described in Table 8.

In column 2 the cardinality of each parameter is described:

- [1..1] indicates that the parameter is required for the document consumer and only one value is allowed.
- [0..1] or [0..*] indicates that the parameter is optional for a document consumer, but when using the parameter one [0..1] or multiple [0..*] values are allowed.

- [0..0] indicates "not in use".

Table 8: Description of parameters in the stored query FindDocuments

Name Attribute	Card.	Original descriptions (from ITI TF-2a)	Norwegian National Extension
\$XDSDocumentEntry PatientId XDSDocumentEntry.patientId	[1..1]	<p>The patientId represents the subject of care of the document.</p> <p>It contains the Health ID with its two parts:</p> <p>Authority Domain Id (OID enforced by the Registry)</p> <p>An Id in the above domain issued by the PDQ Supplier Actor.</p> <p>The format of the patientId value is CX.</p> <p>See also ITI TF-3, 4.2.3.2.16</p>	<p>Allowed national patientIds: Birthnr (F-nr). OID = 2.16.578.1.12.4.1.4.1</p> <p>Temporary nr (D-nr): 2.16.578.1.12.4.1.4.2</p> <p>Common help nr: (FH-nr): 2.16.578.1.12.4.1.4.3</p> <p>Example (F-nr):</p> <pre><rim:Slot name= "\$XDSDocumentEntryPatientI d"> <rim:ValueList> <rim:Value> 12345612345^^^&2.16.578.1. 12.4.1.4.1&ISO</rim:Value> </rim:ValueList> </rim:Slot></pre>
\$XDSDocumentEntry ClassCode XDSDocumentEntry.classCode	[0..*]	<p>The code specifying the high-level use classification of the document type (e.g., Report, Summary, Images, Treatment Plan, Patient Preferences, Workflow).</p> <p>See also ITI TF-3, 4.2.3.2.3</p>	<p>This attribute MUST represent a value from the Norwegian Metadata Value-Set Dokumenttyper 9602 (OID: 2.16.578.1.12.4.1.1.9602) (from volven.no); Level 1 Example (A00-1 Epikriser og sammenfatninger):</p> <pre><rim:Slot name="\$XDSDocumentEntryCla ssCode"> <rim:ValueList> <rim:Value> 'A00- 1^^2.16.578.1.12.4.1.1.960 2' </rim:Value> </rim:ValueList> </rim:Slot></pre>
\$XDSDocumentEntry TypeCode XDSDocumentEntry.typeCode	[0..*]	<p>The code specifying the precise type of document from the user perspective.</p> <p>See also ITI TF-3, 4.2.3.2.25</p>	<p>This attribute MUST represent a value from the Norwegian Metadata Value-Set Dokumenttyper 9602 (OID:</p>

Name Attribute	Card.	Original descriptions (from ITI TF-2a)	Norwegian National Extension
typeCode			<p>2.16.578.1.12.4.1.1.9602) (from volven.no);, Level 2 Example (A03-2 Epikrise):</p> <pre><rim:Slot name="\$XDSDocumentEntryClassCode"> <rim:ValueList> <rim:Value> 'A03- 2^^2.16.578.1.12.4.1.1.960 2' </rim:Value> </rim:ValueList> </rim:Slot></pre>
<p>\$XDSDocumentEntry PracticeSettingCode</p> <p>XDSDocumentEntry.practiceSettingCode</p>	[0..*]	<p>The code specifying the clinical specialty where the act that resulted in the document was performed (e.g., Family Practice, Laboratory, Radiology).</p> <p>See also ITI TF-3, 4.2.3.2.17</p> <p>Remark 1: <i>The value sets are not specific for practical usage. Until further notice practical usage of this parameter will not be required for systems that support the role Document Registers.</i></p> <p>Remark 2: <i>HSØ's EHR product accepts the parameter but do not filter the result based on this parameter</i></p>	<p>When specified, this attribute MUST represent a value from the Norwegian Metadata Value-Sets defined in the Norwegian IHE XDS metadata profile</p>
<p>\$XDSDocumentEntry CreationTimeFrom</p> <p>Lower value of XDSDocumentEntry.creation Time</p>	[0..1]	<p>creationTime represents the time the author created the document.</p> <p>See also ITI TF-3,4.2.3.2.6</p>	<p>Example:</p> <pre><rim:Slot name="\$XDSDocumentEntryCreationTimeFrom"> <rim:ValueList> <rim:Value>200412252300 </rim:Value> </rim:ValueList> </rim:Slot></pre>
\$XDSDocumentEntry CreationTimeTo	[0..1]		

Name Attribute	Card.	Original descriptions (from ITI TF-2a)	Norwegian National Extension
Upper value of XDSDocumentEntry.creationTime			
\$XDSDocumentEntry ServiceStartTimeFrom Lower value of XDSDocumentEntry.serviceStartTime	[0..1]	Represents the start time of the service being documented took place (clinically significant, but not necessarily when the document was produced or approved). See also ITI TF-3, 4.2.3.2.19	
\$XDSDocumentEntry ServiceStartTimeTo Upper value of XDSDocumentEntry.serviceStartTime	[0..1]		
\$XDSDocumentEntry ServiceStopTimeFrom Lower value of XDSDocumentEntry.serviceStopTime	[0..1]	Represents the stop time of the service being documented took place (clinically significant, but not necessarily when the document was produced or approved).	
\$XDSDocumentEntry ServiceStopTimeTo Upper value of XDSDocumentEntry.serviceStopTime	[0..1]	See also ITI TF-3, 4.2.3.2.20	

Name Attribute	Card.	Original descriptions (from ITI TF-2a)	Norwegian National Extension
<p>\$XDSDocumentEntry HealthcareFacilityTypeCode</p> <p>XDSDocumentEntry. healthcareFacilityTypeCode</p>	[0..*]	<p>This code represents the type of organizational setting of the clinical encounter during which the documented act occurred.</p> <p>See also ITI TF-3, 4.2.3.2.11</p> <p>Remark: <i>Until further notice usage of this parameter will not be required for systems that support the role Document Registers.</i></p>	<p>When specified, this attribute MUST represent a value from the Norwegian Metadata Value-Set:</p> <p>1303 Næringstype (SN 2007) shall be used:</p> <p>Examples:</p> <p>86.211 Allmenn legetjeneste</p> <p>86.212 Somatiske poliklinikker</p> <p>86.221 Spesialisert legetjeneste, unntatt psykiatrisk legetjeneste</p>
<p>\$XDSDocumentEntry EventCodeList</p> <p>XDSDocumentEntry. eventCodeList</p>	[0..0]	<p>This list of codes represents the main clinical acts, such as a colonoscopy or an appendectomy being documented.</p> <p>See also and ITI TF-3, 4.2.3.2.8</p>	<p>Not in use.</p> <p>MUST NOT be specified ([0..0]).</p>
<p>\$XDSDocumentEntry ConfidentialityCode</p> <p>XDSDocumentEntry. confidentialityCode</p>	[0..*]	<p>The code specifying the security and privacy tags of the document.</p> <p>See also ITI TF-3, 4.2.3.2.5</p> <p>Remark 1: <i>HSØ's EHR product accepts the parameter but does not filter the result based on this parameter</i></p>	<p>When specified, this attribute MUST represent a value from the Norwegian Metadata Value Set:</p> <p>See last version of Norwegian profile of IHE metadata for details.</p>
<p>\$XDSDocumentEntry AuthorPerson</p> <p>XDSDocumentEntry. author</p>	[0..*]	<p>Represents the humans and/or machines that authored the document.</p> <p>See also ITI TF-3 4.2.3.2.1</p> <p>Remark 1: <i>HSØ's EHR product accepts the parameter but does not filter the result based on this parameter</i></p>	<p>This attribute MUST follow XCN HL7 v2.5 Extended Person Name datatype. Following values shall be used:</p> <ul style="list-style-type: none"> • Identifier • Last Name • First Name • Second and Further Given Names <p>Example where searching after documents with author "Magnar Koman" with HPR-</p>

Name Attribute	Card.	Original descriptions (from ITI TF-2a)	Norwegian National Extension
			<p>nr 9144889:</p> <pre><rim:Slot name="\$XDSDocumentEntryAuthorPerson"> <rim:ValueList> <rim:Value> 9144889^Koman^Magnar^^^^^& ; 2.16.578.1.12.4.1.4.4&ISO </rim:Value> </rim:ValueList> </rim:Slot></pre>
<p>\$XDSDocumentEntry FormatCode</p> <p>XDSDocumentEntry.formatCode</p>	[0..*]	<p>The code specifying the detailed technical format of the document.</p> <p>See also ITI TF-3, 4.2.3.2.9</p> <p>Remark 1: <i>HSØ's EHR product accepts the parameter but does not filter the result based on this parameter</i></p>	<p>When specified, this attribute MUST be a valid value (see sarepta.ehelse.no for list of valid values)</p> <p>Example searching epikrise v1.1:</p> <pre><rim:Slot name="\$XDSDocumentEntry FormatCode "> <rim:ValueList> <rim:Value> urn:no:kith:xmlstds:epikri se:2006-09-23 </rim:Value> </rim:ValueList> </rim:Slot></pre>
<p>\$XDSDocumentEntryStatus</p> <p>XDSDocumentEntry.status</p>	[1..*]	<p>Represents the status of the DocumentEntry. A DocumentEntry shall have one of two availability statuses:</p> <p>Approved: The document is available for patient care.</p> <p>Deprecated: The document is obsolete.</p> <p>See also ITI TF-3, 4.2.3.2.2</p>	<p>A value MUST be used:</p> <p>urn:oasis:names:tc:ebxml-regrep:StatusType:Approved or urn:oasis:names:tc:ebxml-regrep:StatusType:Deprecated</p>
<p>\$XDSDocumentEntryType</p> <p>XDSDocumentEntry.objectType</p>	[0..*]	<p>The objectType attribute reflects the type of DocumentEntry. As described in ITI TF-3, Section 4.1.1, there are two DocumentEntry types: Stable Document Entry and On-Demand Document Entry.</p> <p>See also ITI TF-3, 4.2.3.2.30</p>	<p>A value MUST be used:</p> <p>urn:uuid:7edca82f-054d-47f2-a032-9b2a5b5186c1 (Stable documents)</p>

3.6.2 Parameters for stored query GetDocuments

Retrieve a collection of XDSDocumentEntry objects. XDSDocumentEntry objects are selected either by their entryUUID or uniqueId attribute. See Table 9 for description of parameters.

Table 9 Description of parameters in the stored query GetDocuments

Name Attribute	Card.	Original descriptions (from ITI TF-2a)	Norwegian National Extension
\$XDSDocumentEntry EntryUUID	[0..*]	See below	None
\$XDSDocumentEntry UniqueId	[0..*]	Either \$XDSDocumentEntryEntryUUID or \$XDSDocumentEntryUniqueId shall be specified. This transaction shall return an XDSSStoredQueryParamNumber error if both parameters are specified. Ref: IHE ITI-2a 3.18.4.1.2.3.7.5	None
\$homeCommunityId	[0..1]	Document Consumer Actors shall specify the homeCommunityId value if they received a value for this attribute as part of the previous Registry Stored Query response entry which contained the specified EntryUUID or UniqueID. See Section 3.18.4.1.2.3.8 for more details	None

3.6.3 Response

In FindDocuments stored queries, a Document Consumer can choose between two response types:

1. ObjectRef: Returns only the documents' unique identifiers (UUID and homeCommunityID)
2. LeafClass: Returns all metadata the system can return.

When the response type "LeafClass" is used in an ITI-18 FindDocument or GetDocuments stored query, the Document Register shall always return at least all required metadata as described in the Norwegian IHE XDS metadata profile.

An example response is included in chapter 5.

3.6.4 Audit log

A Document Consumer shall include the following objects in the audit message:

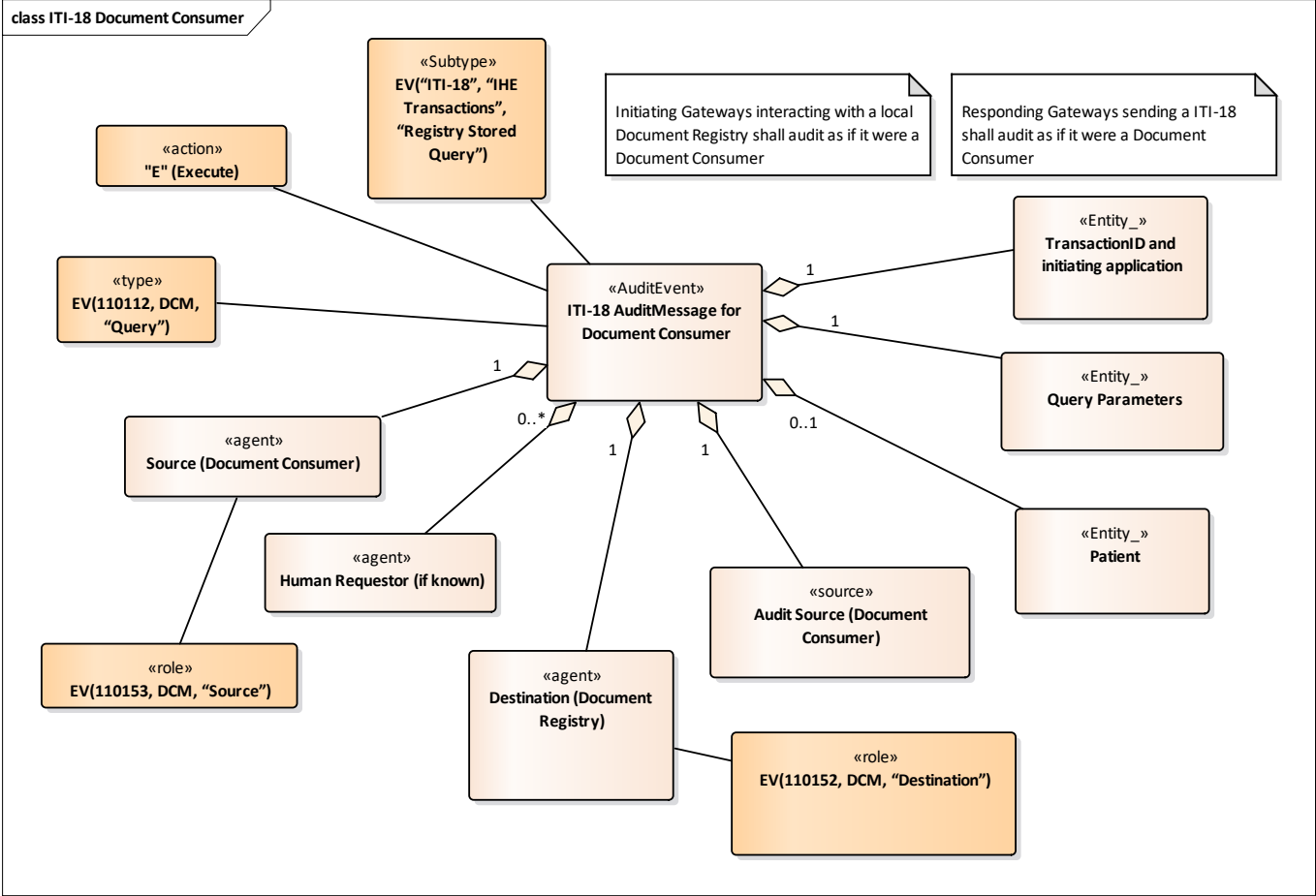

A Document Register shall include the following objects in the audit message:

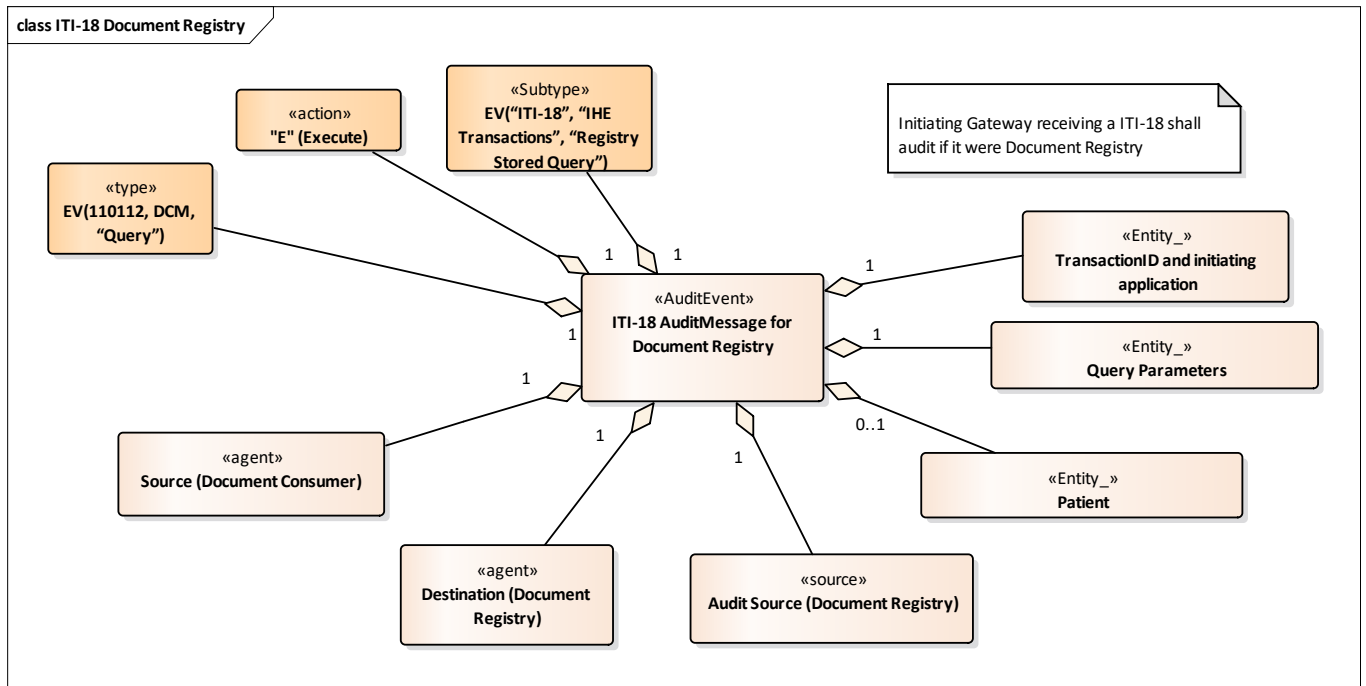

3.7 ITI-43 Retrieve Document

ITI-43 is used by Document Consumer and XCA gateway to retrieve one or a set of documents from Document Repository.

3.7.1 Request

The Document Consumer must use the following attributes received from Document Registry via ITI-18 Registry Stored Query:

1. DocumentEntry ID: documentUniqueId,
2. Document Repository ID: repositoryUniqueId and
3. Affinity domain ID: homeCommunityID

Example:

```

<ns2:RetrieveDocumentSetRequest xmlns:ns2="urn:ihe:iti:xds-b:2007">
  <ns2:DocumentRequest>
    <ns2:HomeCommunityId>urn:oid:2.16.578.1.12.4.1.2.5600</ns2:HomeCommunityId>
    <ns2:RepositoryUniqueId>2.16.578.1.12.4.1.2.5601</ns2:RepositoryUniqueId>
    <ns2:DocumentUniqueId>354495d6-5fc4-4824-b881-1c28bd04242c</ns2:DocumentUniqueId>
  </ns2:DocumentRequest>
</ns2:RetrieveDocumentSetRequest>
  
```

3.7.2 Response

The Response must be a Retrieve Document Set Response message.

In this message a RegistryResponse must be included which contain a status of type ResponseStatusType that provides the overall status of the request.

For each document the response message must return:

1. documentUniqueId,
2. repositoryUniqueId
3. homeCommunityID
4. mimeType
5. The retrieved document as a XOP Infoset
6. Errors or warnings in case the document(s) could not be retrieved successfully

An example response message is included in chapter 5.

3.7.3 Audit log

A Document Consumer shall include the following objects in the audit message:

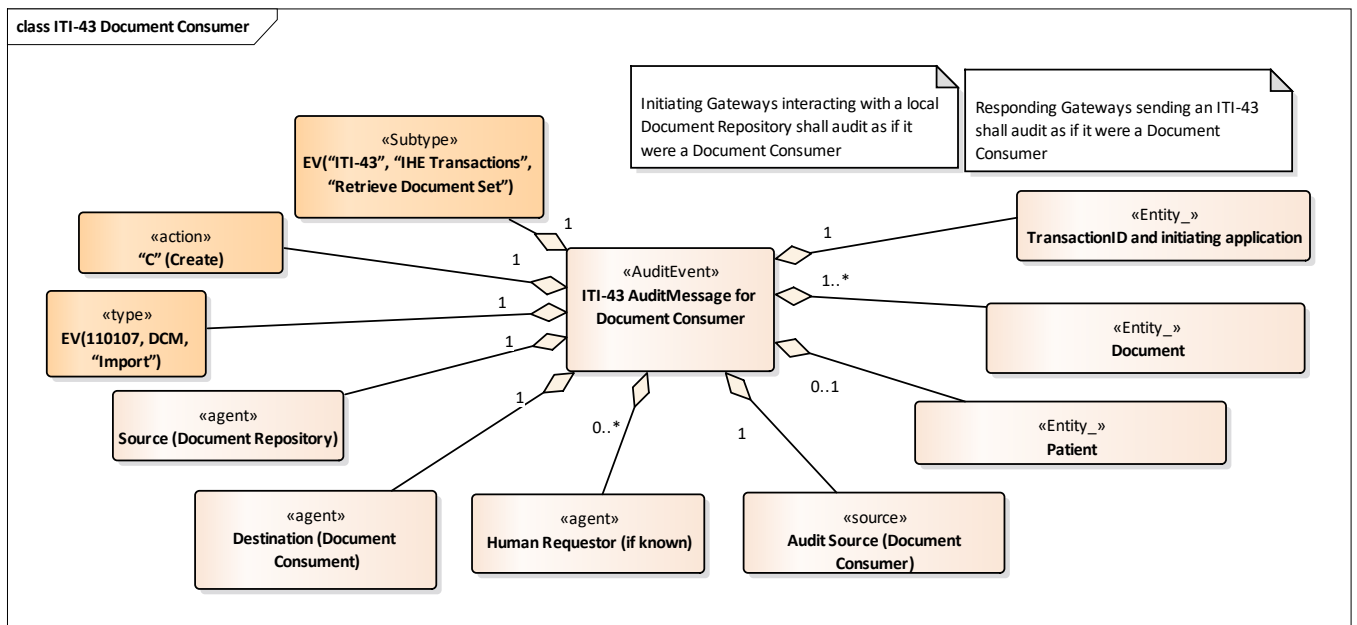

A Document Repository shall include the following objects in the audit message:

class ITI-43 Document Repository

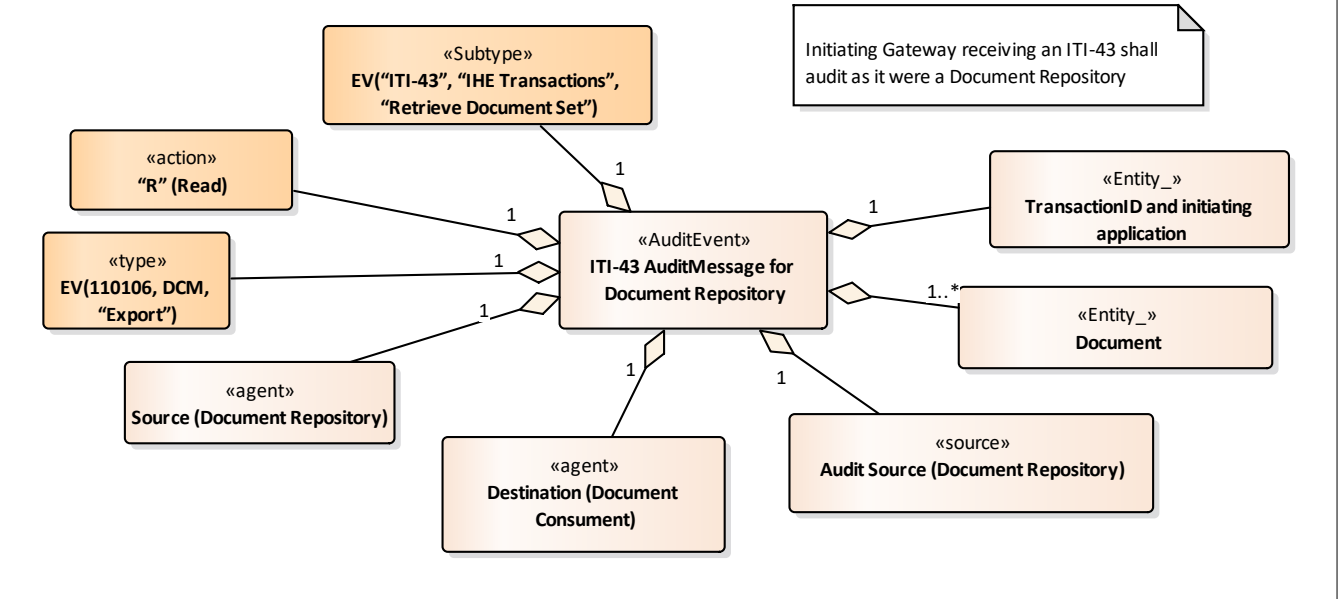

3.8 ITI-38 Cross Gateway Query

The scope of the Cross Gateway Query transaction is based on the Registry Stored Query [ITI18] transaction. The same set of stored queries is required to be supported in both of these transactions, namely FindDocuments and GetDocuments (see description on ITI-18).

The Cross Gateway Query is always between an Initiating Gateway and Responding Gateway.

National usage of ITI-38 will not support the following:

- Stored queries that rely on concepts that a community may not support, namely associations, folders and submission sets. A Responding Gateway can respond with zero entries for such stored queries.
- the Asynchronous Web Services Exchange Option.

ITI TF-2b chapter 3.38.1 states that there shall be an agreed upon common coding/vocabulary scheme used for the Cross Gateway Query to prevent any need of transformation between an Initiating Gateway and a Responding Gateway. As common coding/vocabulary scheme the Norwegian XDS metadata profile shall be used. Each actor who sends or receives an ITI-38 must therefore be compliant with the Norwegian XDS metadata profile.

An Initiating Gateway shall ensure that:

- Each "getDocuments" stored query must include a homeCommunityID.
- A received "getDocuments" request including multiple documents only includes one homeCommunityID.
- Each Cross Gateway Query request includes at most one homeCommunityID.

Each community must have a unique homeCommunityID. An Initiating Gateway must administrate a directory of all communities. The directory must include for each community at least one homeCommunityIDs and the corresponding Responding Gateway(s) which serves the community. An Initiating Gateway must support that a Responding Gateway can serve multiple communities (multiple homeCommunityIDs) and that a Community can have multiple Responding Gateways.

3.8.1 XDS Affinity Domain Option is required for all Initiating Gateways

An Initiating Gateway must support the XDS Affinity Domain Option which means that the gateway must support receiving ITI-18 requests.

When an Initiating Gateway with the XDS Affinity Domain Option enabled receives an ITI-18 FindDocuments stored query, it shall generate and send an ITI-38 Cross Gateway Query to each registered community. Each response shall be aggregated in an ITI-18 response. All successes and failures received from different Responding Gateways shall be reflected in the response.

Grouping of actors

IHE ITI-1 chapter 18.2.3 describes permitted groupings of actors.

When an Initiating Gateway is supporting an XDS Affinity Domain, it can choose to query (with ITI-18) and retrieve (with ITI-43) from local actors in addition to remote communities. This is accomplished by grouping the Initiating Gateway with a Document Consumer Actor. This grouping allows Document Consumers such as EHR/PHR/etc. systems to query the Initiating Gateway to retrieve document information and content from both the local XDS Affinity Domain as well as remote communities.

3.8.2 Audit log

An Initiating gateway shall include the following objects in the audit message for ITI-38:

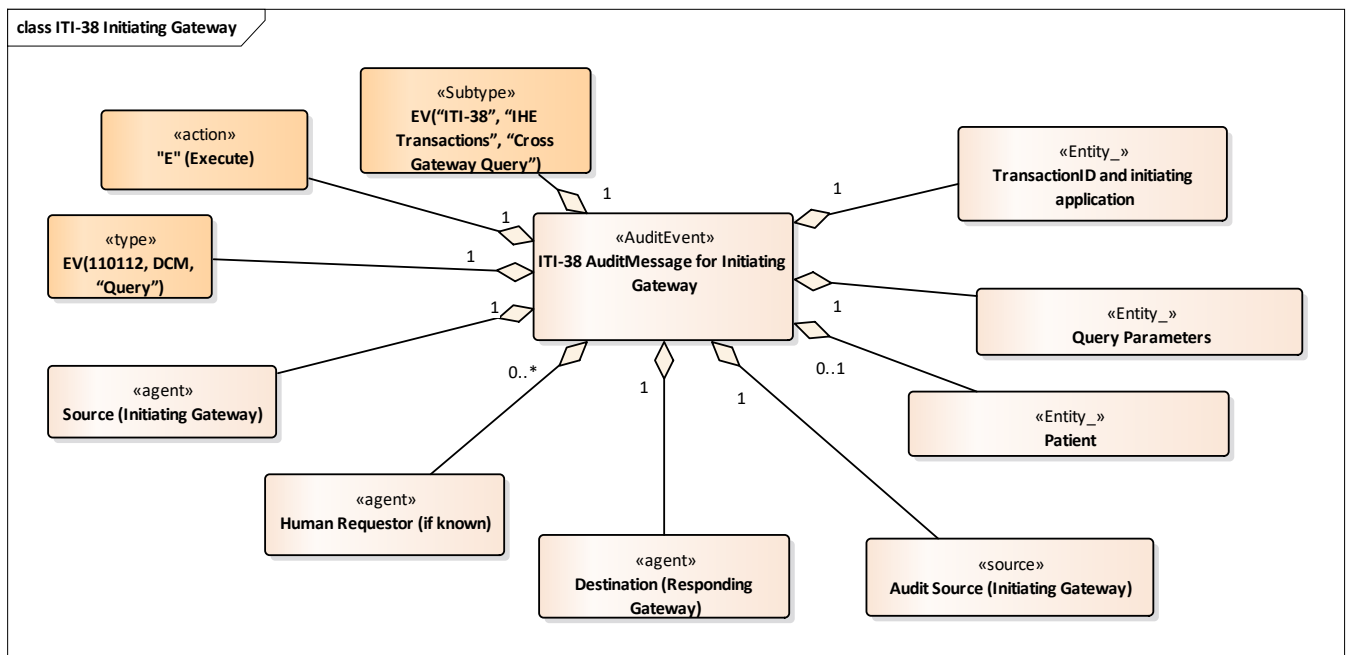

A Responding gateway shall include the following objects in the audit message for ITI-38:

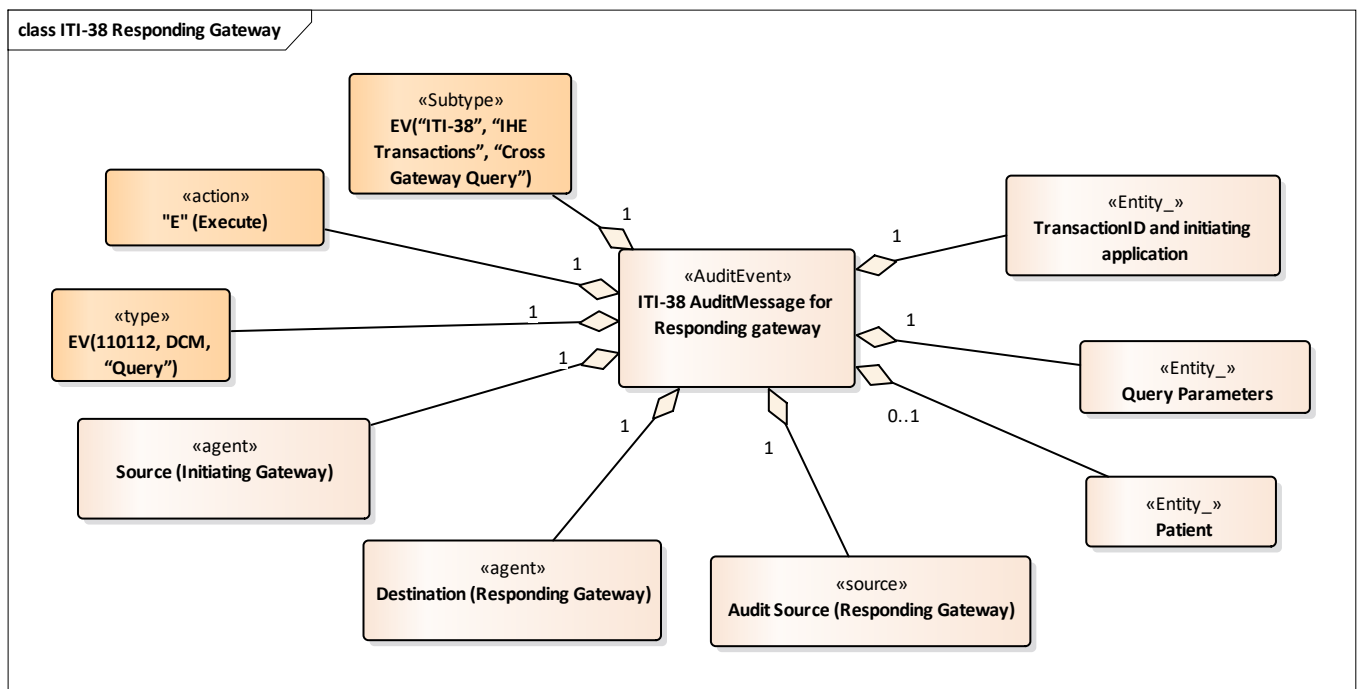

3.9 ITI-39 Cross Gateway Retrieve

The scope of the Cross Gateway Retrieve transaction is semantically the same as the Retrieve Document Set [ITI-43] transaction.

The Cross Gateway Retrieve is always just between an Initiating Gateway and a Responding Gateway.

In Norway it is not a requirement to support the Asynchronous Web Services Exchange Option which is normally a mandatory option for Responding Gateways.

3.9.1 XDS Affinity Domain Option is required for an Initiating Gateway

An Initiating Gateway must support the XDS Affinity Domain Option which means that the gateway must support receiving ITI-43 requests.

The IHE profile specifies that an ITI-43 request can include request for multiple documents which resides in different communities. An Initiating Gateway must therefore support to send an ITI-39 transaction to each community and aggregate the received results in an ITI-43 response.

3.9.2 Audit log

An Initiating gateway shall include the following objects in the audit message for ITI-43:

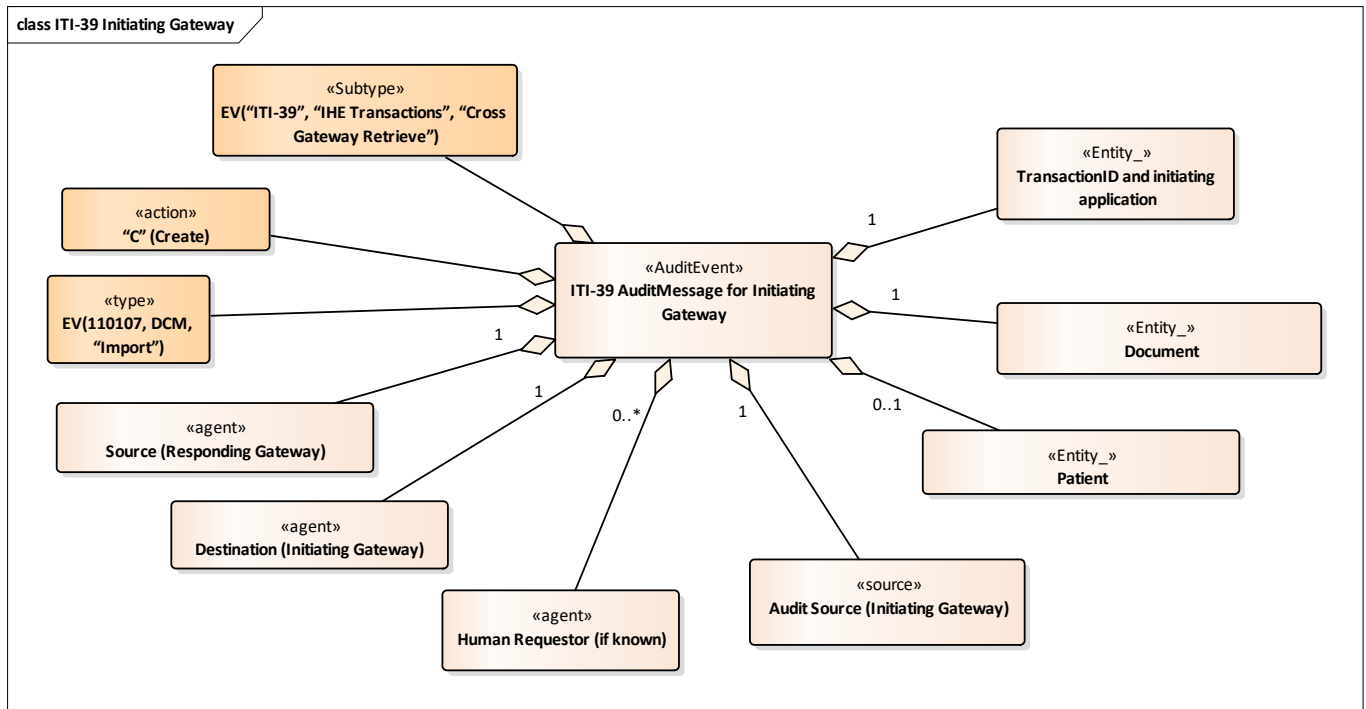

A Responding gateway shall include the following objects in the audit message for ITI-43:

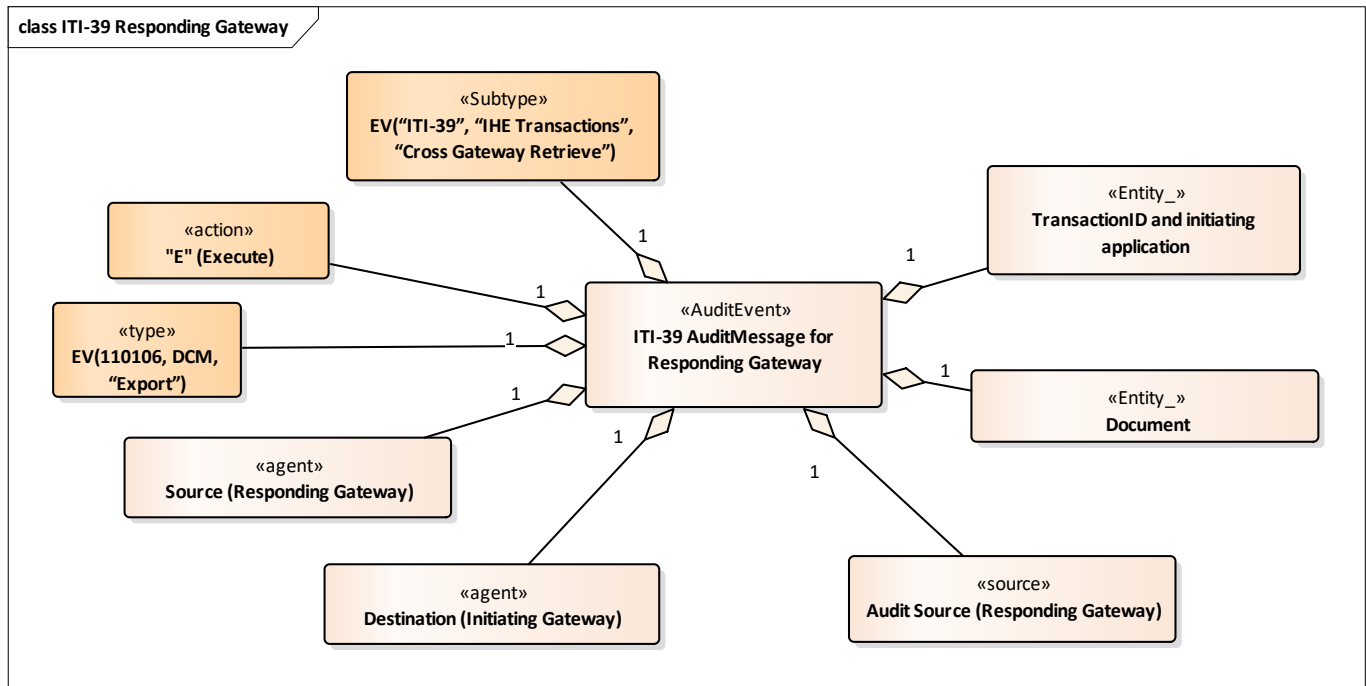

4 XUA – Cross-Enterprise User Assertion

The use of national document sharing requires a secure environment and therefore strong authentication and access control mechanisms within the communities. As a proof of the user's identity and associated assertions, the architecture is based on the transaction "Provide X-User Assertion" [ITI-40] of the IHE Cross-Enterprise User Assertion (XUA) integration profile. In addition, the transactions "Authenticate User" and "Get X-User Assertion" must be supported in order to achieve the level of security needed to get access to clinical information.

Figure 7 shows the actors and transactions defined in IHE XUA. The actors and transactions must support the following use cases:

- Asserting the authenticity of a user: "Authenticate User"
- Asserting declarative attributes: "Get X-User Assertion"
- Resolving assertions for On Behalf use cases (for citizen users): "Get X-User Assertion"
- Providing assertions to X-Service Providers: "Provide X-User Assertion [ITI-40]"

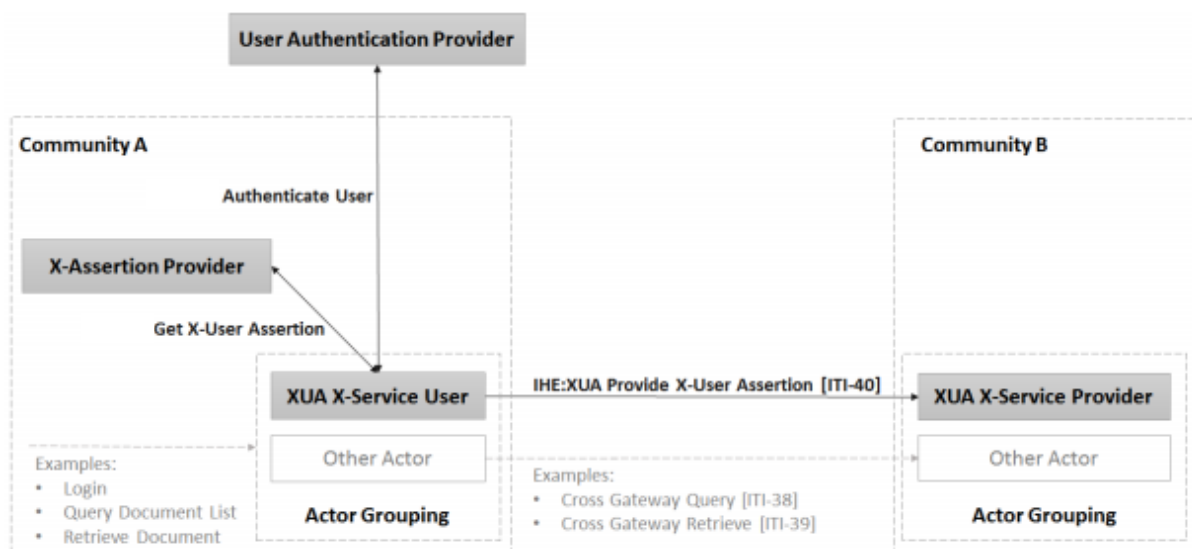

Figure 7: XUA actors in cross-community communications

In the rest of this chapter we will describe in detail each roles' responsibilities and each transaction.

4.1 XUA roles

4.1.1 X-Service User

X-Service User actor is defined and specified in IHE XUA. Its responsibility is to provide a valid SAML User Assertion using the IHE transaction Provide X-User Assertion [ITI-40]. The contents of the SAML User Assertion contain all information needed by the X-Service Provider actor to check the access authorization for a specific resource.

The X-Service User actor **MUST** be grouped with any application that uses any services of Document Registries and Repositories within the same community or across communities.

X-Service User actors combined with the Document Consumer actor which initiates a query or retrieval of documents **MUST**:

- implement the OpenID Connect Authenticate flow of «Authenticate User» transaction specified by HelseID or Innbygger-STS
- implement the Get X-User Assertion Request specified in 4.2.2
- implement the Provide X-User Assertion [ITI-40] transaction specified by the IHE XUA integration profile
- be able to manage the certificates used in cross community communication

X-Service User actors combined with the Initiating gateway actor or other system acting as a Document Consumer (which is not the initiating Document Consumer):

- implement the Provide X-User Assertion [ITI-40] transaction specified by the IHE XUA integration profile
- be able to manage the certificates used in cross community communication

4.1.2 X-Service Provider

This actor is defined and specified in IHE XUA. Its responsibility is to receive SAML User Assertions according to the IHE transaction Provide X-User Assertion [ITI-40] and to delegate the authorization of access to a specific resource.

This actor **MUST** be grouped with an actor with the responsibility to make authorization decisions. IN XDS/XCA context this actor must be combined with the Initiating Gateway actor, Responding Gateway actor, Document Register actor and Document Repository actor.

X-Service Provider actors **MUST**:

- be able to manage the certificates used in cross community communication
- implement the Provide X-User Assertion [ITI-40] specified by the IHE XUA integration profile

4.1.3 X-Assertion Provider

This actor is defined in IHE XUA, but not further specified. Its responsibility is to create XUA compliant SAML User Assertions for access authorization.

There are two X-assertion providers in the Norwegian healthcare sector today. HelseID for health professional usage and Innbygger-STS for citizen usage.

For health professional usage it is required to use a HelseID API for issuing SAML Secure Token (see 4.2.2).

For citizen usage an API on Innbygger-STS must be used. Today Helsenorge is the only user of this API.

X-Assertion Provider actors MUST:

- implement the SAML User Assertion Response transaction "Get X-User Assertion"
- maintain a list of trusted User Authentication Providers to validate assertions issued by these providers
- maintain a list of trusted Document Consumers authorized to call the "Get X-User Assertion" API
- have their public keys published so that other actors (X-Service User, Authorization Decision Provider, etc.) may validate the authenticity of the signed SAML User Assertions

4.1.4 User Authentication Provider

This actor is defined in IHE XUA profile of the IHE Technical Framework, but without detailing the specification of the transactions. HelseID will administrate a list of accepted providers for health professional users and ID-porten (national joint login solution) for citizens. Examples of accepted User Authentication providers for citizens on Helsenorge: BankID, Buypass and Commfides.

4.2 Transactions

4.2.1 Authenticate User

This transaction is defined in IHE XUA profile of the IHE Technical Framework, but without detailing the specification of the transactions. In Norway OpenID Connect protocol is used on HelseID and Innbygger-STS to authenticate users.

The required security level/trust level is authentication of electronic identities with security level 4. This may be changed later for authentication of health professionals.

4.2.2 Get X-User Assertion

This transaction is defined in IHE XUA profile of the IHE Technical Framework, but without detailing the specification of the transactions. This transaction must be used when an authenticated user, according to the «Authenticate User» transaction, accesses a protected resource of a system within the national document sharing community. This includes the transactions search for documents of a patient and retrieve a document.

4.2.2.1 Operation for retrieving SAML based XUA token on HelseID API

Health professional usage involves use of HelseID as the X-Assertion Provider. HelseID has a REST API which implements the "Get X-User Assertion" operation. In Table 10 the REST API is described.

Table 10 Get X-User Assertion methods

Operation	Header	Body	Response	Comment
token	Authorization Bearer {Helseid access token}	Signed JWT	SAML	Requires HelseID access token in header and a signed JWT with claims from Document Consumer (X-Service user) in body (described below). Returns a SAML based XUA token as plain text in response
ping			pong	Standard ping service to test communication.

Specification Signed JWT

The JWT must be signed with the company's certificate to identify who is asking for issuing a XUA token. The signed JWT must be included in the request's body and must contain the claims listed in Table 11.

Table 11 Claims a JWT must contain

Claim code	Claim Name	Claim value description
sub	Subject	Identifies the subject (user) of the JWT.
iss	Issuer	Identifies the principal that issued the JWT.
subject:organization		The organization name the subject works for.
subject:organization-id		The organization number the subject works for.
subject:role		User's current role
homeCommunityId		XDS home community id
subject:purposeofUse		The purpose of the request
resource:resource-id		Identifies the person (patient) the token is valid for.
aud	Audience	Identifies the recipients that the JWT is intended for.

Claim code	Claim Name	Claim value description
exp	Expiration Time	Identifies the expiration time on and after which the JWT must not be accepted for processing.
iat	Issued at	Identifies the time at which the JWT was issued.
scope	Scope	The scope the token is valid for.
nbf	Not Before	Identifies the time at which the JWT will start to be accepted for processing.
jti	JWT ID	Case sensitive unique identifier of the token even among different issuers.

4.2.3 Provide X-user Assertion – ITI-40

See ITI TF-2b, chapter “3.40 Provide X-User Assertion [ITI-40]”. The SAML User Assertion MUST be taken from the Get X-User Assertion transaction and included in any document sharing transaction such as ITI-18.

4.3 Summary

Figure 8 shows how each role and transaction fit together in an example where Kjernejournal is the initiating Document Consumer.

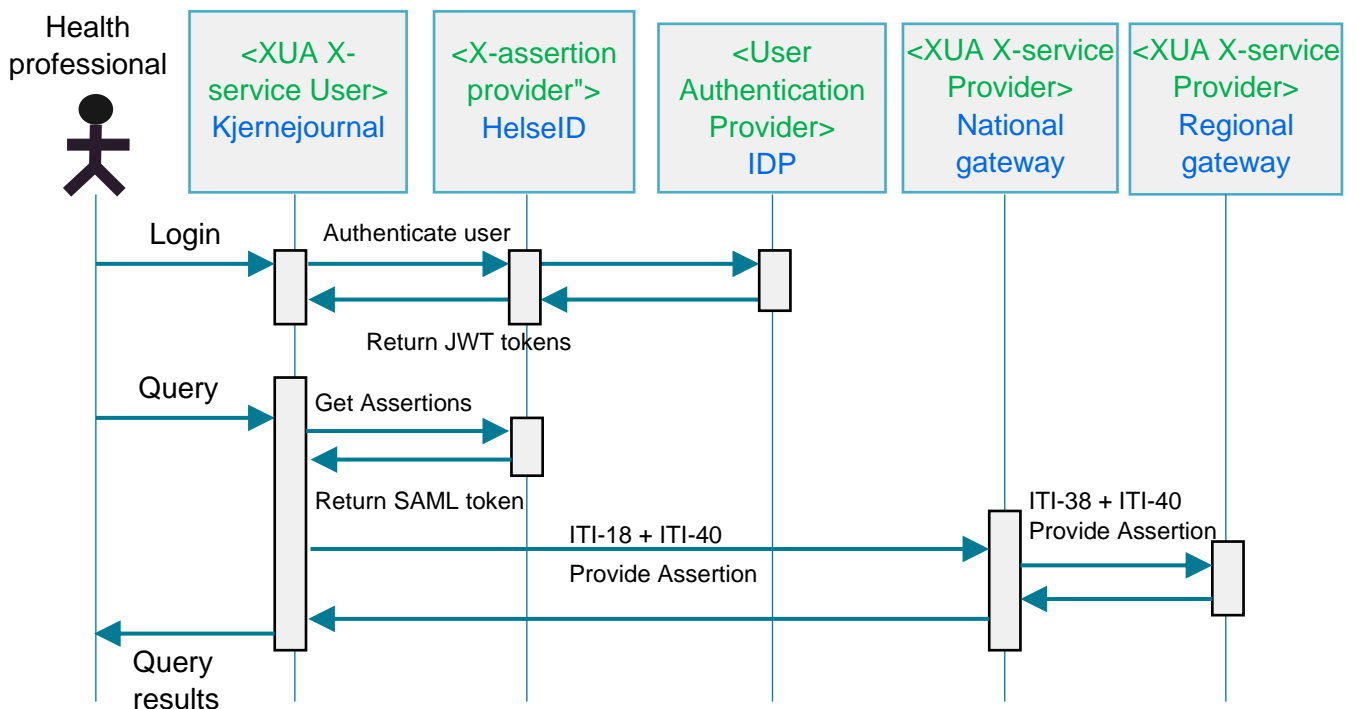

Figure 8: Sequence diagram of secure cross community communication for ITI-18/ITI-38

4.4 XUA SAML User Assertion

This chapter specifies a Norwegian profile of SAML attributes included in an XUA Provide X-User Assertion [ITI-40]. ITI-40 is a profile and extension of the "Assertions and Protocols for the OASIS Security Assertion Markup Language (SAML) V2.0" (saml-core-2.0-os).

Name Attribute	National extension	Card: HP usage	Card: Citizen usage	Datatype	Original descriptions (from ITI TF-2b)	Norwegian National Extension
NameID	-	[1..1]	[1..1]	String	Identify the subject of a SAML assertion	<p><u>HP usage:</u> National ID (f-nr) or another unique user_ID used to identify the logged in user (see NameQualifier). For national usage, a national ID system must be used: Either f-nr, d-nr or "felles hjelpenummer"(not supported yet).</p> <p><u>Citizen usage:</u> National ID (f-nr)</p> <pre><Subject> <NameID>13116900216</NameID> <SubjectConfirmation Method="urn:oasis:names:tc:SAML:2.0:cm:bearer" /> </Subject></pre>
@NameQualifier		[0..1]	[0..1]	String		<p>When using another user_ID identification than the National Norwegian ID (f-nr) it is allowed to use NameQualifier. If NameQualifier is used, the identification system of the user_ID must be given as an OID number: "urn:oid:<oid-number>" where <oid-number> is given by:</p>

Name Attribute	National extension	Card: HP usage	Card: Citizen usage	Datatype	Original descriptions (from ITI TF-2b)	Norwegian National Extension
						https://git.sarepta.ehelse.no/utvikling/FHIR/wikis/personidentifikatorer . Example (d-number): <NameID NameQualifier= "urn:oid:2.16.578.1.12.4.1.4.2"> 13116900216</NameID>
subject:subject-id		[1..1]	[1..1]	String	Subject contains the logical identifier of the principal performing the original service request (person, application, etc.) Subject ID: The value of the Subject ID attribute shall be a plain text description of the user's name (not user ID).	HP usage: Name of logged in user Citizen usage: Name of logged in user <saml:Attribute Name=urn:oasis:names:tc:xspa:1.0:subject:subject-id"> <saml:AttributeValue> ROLF FOS LILLEHAGEN </saml:AttributeValue> </saml:Attribute>
subject:organization		[1..*]	[1..1]	String	The value of the Subject Organization attribute shall be a plain text description of the organization: This element shall have the Name attribute set to "urn:oasis:names:tc:xspa:1.0:subject:organization". In plain text, the organization that the user	HP usage: Name of the legally responsible organization from which the initial query originates. Citizen usage: Default value: "Norsk Helsenett" <saml:Attribute Name="urn:oasis:names:tc:xspa:1.0:subject:organization">

Name Attribute	National extension	Card: HP usage	Card: Citizen usage	Datatype	Original descriptions (from ITI TF-2b)	Norwegian National Extension
					belongs to shall be placed in the value of the element.	<pre><saml:AttributeValue> Norsk Helsenett </saml:AttributeValue> </saml:Attribute></pre>
subject:organization-id		[1..*]	[1..1]	HL7 v3 Instance Identifier (II)		<p>HP usage: Unique ID of the legally responsible organization from which the initial query originates. The identity system shall always be based on IDs from Brønnøysundregistrene ("organisasjonsnummer").</p> <p>Citizen usage: Default value: "994598759" (the organization number of "Norsk Helsenett")</p> <pre><saml:Attribute Name="urn:oasis:names:tc:xspa:1.0:subject:organization-id"> <saml:AttributeValue> <id xmlns="urn:hl7- org:v3" type="II" extension="994598759" root="2.16.578.1.12.4.1.4.101" assigningAuthorityName="Brønnøysundr egistrene" displayable="false" />; </saml:AttributeValue> </saml:Attribute></pre>
subject:child-organization	Yes	[0..1]	[0..0]	HL7 v3 Instance Identifier (II)		The unique identifier of the sub-organization of the Service Consumer.

Name Attribute	National extension	Card: HP usage	Card: Citizen usage	Datatype	Original descriptions (from ITI TF-2b)	Norwegian National Extension
						<p>HP usage: ID of the lowest formal organizational unit an employee belongs to.</p> <p>Citizen usage: NOT IN USE</p> <pre><saml:Attribute Name="urn:oasis:names:tc:xspa:1.0:subject:child-organization"> <saml:AttributeValue> <id xmlns="urn:hl7-org:v3" type="II" extension="700386" root="2.16.578.1.12.4.1.4.102" assigningAuthorityName" Norsk Helsenett SF" displayable="false" />; </saml:AttributeValue> </saml:Attribute></pre>
subject:facility	Yes	[0..1]	[0..0]	String		<p>The unique identifier of the facility of the Service Consumer.</p> <p>HP usage: Geographical affiliation for the logged in employee</p> <p>Citizen usage: NOT IN USE</p> <pre><saml:Attribute Name="urn:oasis:names:tc:xspa:1.0:subject:facility"> saml:AttributeValue> <id xmlns="urn:hl7-org:v3" type="II" extension="222200063" root="2.16.578.1.12.4.1.4.101"</pre>

Name Attribute	National extension	Card: HP usage	Card: Citizen usage	Datatype	Original descriptions (from ITI TF-2b)	Norwegian National Extension
						<pre> assigningAuthorityName="Brønnøysundregistrene" displayable="false" /> </saml:AttributeValue> </saml:Attribute> </pre>
subject:role		[1..1]	[0..0]	HL7 CE	The code attribute shall contain the role code from the identified Value-Set that represents the role of the XUA user when making the request.	<p><u>HP usage:</u> volven.no coding system nr 9060. ex:</p> <pre> </rim:Value> <Role xmlns="urn:h17-org:v3" xsi:type="CE" code="LE" codeSystem="2.16.578.1.12.4.1.1.9060&ISO" codeSystemName="kategori helsepersonell" displayName="Lege"/> </pre> <p><u>Citizen usage:</u> NOT IN USE</p>
homeCommunityId		[1..1]	[1..1]	String	The value shall be the Home Community ID (an Object Identifier) assigned to the Community initiating the request	<p><u>HP usage:</u> Unique ID of type OID for initiating community</p> <p><u>Citizen usage:</u> Always the national community with OID: 2.16.578.1.12.4.1.7.1.2</p> <pre> <saml:Attribute Name="homeCommunityId"> <saml:AttributeValue> 2.16.578.1.12.4.1.7.1.2 </saml:AttributeValue> </saml:Attribute> </pre>
subject:npi		[1..1]	[1..1]	String	A National Provider Identifier (NPI) is a unique identifier issued to health care providers by	<u>HP usage:</u> Health Professional Register identity (HPR-nr)

Name Attribute	National extension	Card: HP usage	Card: Citizen usage	Datatype	Original descriptions (from ITI TF-2b)	Norwegian National Extension
					<p>their national authority (e.g., in the United States this is a 10-digit number assigned by the Centers for Medicare and Medicaid Services (CMS)). When a simple string is used there needs to be a mutually agreed upon assigning authority.</p> <p>The Other Provider Identifier can be used to explicitly show the assigning authority</p>	<p><u>Citizen usage:</u> National ID of the logged in user</p> <pre><saml:Attribute Name="urn:oasis:names:tc:xspa:2.0:subject:npi"> <saml:AttributeValue>222200063 </saml:AttributeValue> </saml:Attribute></pre>
subject:provider-identifier		[1..*]	[1..1]	HL7 v3 Instance Identifier (II)	<p>This attribute is called "Other Provider Identifier" Attribute.</p> <p>Is a unique identifier issued to health care providers by a named authority.</p>	<p>ID for the authenticated user including the type of ID. This attribute makes it easier to identify whether the user is a citizen or health care professional.</p> <pre><saml:Attribute Name="urn:ihe:iti:xua:2017:subject:provider-identifier"> <saml:AttributeValue> <id xmlns="urn:hl7-org:v3" type="II" extension="222200063" root="2.16.578.1.12.4.1.4.4" displayable="false" /> </saml:AttributeValue> </saml:Attribute></pre>
AuthzConsentAcknowledgementDocument		[0..0]	[0..1]	String	When the Authz-Consent Option is supported and a policy identifier needs to be sent, the X Service User shall include the document	<u>HP usage:</u> Not in use

Name Attribute	National extension	Card: HP usage	Card: Citizen usage	Datatype	Original descriptions (from ITI TF-2b)	Norwegian National Extension
					unique ID of the Patient Privacy Policy Acknowledgement Document or include the Patient Privacy Policy Identifier for a policy that has been previously published encoded as SAML attributes	<p><u>Citizen usage:</u> Used when the logged in user represents another patient (for instance a parent represents a child). This attribute is used to give the source of the representation: 2.16.578.1.12.4.1.7.2.2.1: Digital channel 2.16.578.1.12.4.1.7.2.2.2: Analog channel</p> <pre><Attribute FriendlyName="Patient Privacy Policy Acknowledgement Document" Name="urn:ihe:iti:bppc:2007:docid" NameFormat="urn:oasis:names:tc:SAML:2.0:attrname-format:uri"> <AttributeValue xmlns:a="http://www.w3.org/2001/XMLSchema-instance" xmlns:tn="http://www.w3.org/2001/XMLSchema#anyURI" a:type="tn:anyURI"> urn:oid:2.16.578.1.12.4.1.7.2.2.1 </AttributeValue> </Attribute></pre>
AuthzConsentIdentifier		[0..0]	[0..1]	String	The policy identifier shall be expressed using the xs:anyURI data type. The referenced policy identifier is the OID of a published policy.	<p><u>HP usage:</u> Not in use</p> <p><u>Citizen usage:</u> Used when the logged in user represents another patient (for instance a parent represents a child). This attribute must include the type of representation (as an OID</p>

Name Attribute	National extension	Card: HP usage	Card: Citizen usage	Datatype	Original descriptions (from ITI TF-2b)	Norwegian National Extension
						<p>value): 2.16.578.1.12.4.1.7.2.1.1: Parent representation for child under 12 2.16.578.1.12.4.1.7.2.1.2: Consent to represent another citizen 2.16.578.1.12.4.1.7.2.1.3: Representation on behalf of citizen unable to give consent.</p> <pre><Attribute FriendlyName="Patient Privacy Policy Identifier" Name="urn:ihe:iti:xua:2012:acp" NameFormat="urn:oasis:names:tc:SAML:2.0:attrname-format:uri"> <AttributeValue xmlns:a=http://www.w3.org/2001/XMLSchema-instance xmlns:tn="http://www.w3.org/2001/XMLSchema" a:type="tn:anyURI">urn:oid:2.16.578.1.12.4.1.7.2.1.1</AttributeValue> </Attribute></pre>
subject:purposeofUse		[1..1]	[1..1]		The PurposeOfUse element shall contain the coded representation of the Purpose for Use that is in effect for the request.	<p>HP usage: The reason for the query. For Health professional these codes must be used:</p> <p>Code 1: Clinical care provision to an individual subject of care</p>

Name Attribute	National extension	Card: HP usage	Card: Citizen usage	Datatype	Original descriptions (from ITI TF-2b)	Norwegian National Extension
						<p>Code 2: Emergency care provision to an individual subject of care</p> <p><u>Citizen usage:</u> The reason for the query. For Citizen usage this code must be used:</p> <p>Code 13: Subject of care uses</p> <pre><saml:Attribute Name="urn:oasis:names:tc:xspa:1.0:subject:purposeOfUse"> <saml:AttributeValue><PurposeOfUse xmlns="urn:hl7- org:v3" xsi:type="CE" code="1" codeSystem="1.0.14265.1" codeSystemName="ISO 14265 Classifica tion of Purposes for processing personal health information" displayName="Clinical care provision to an individual subject of care"/> </saml:AttributeValue> </saml:Attribute></pre>
resource:resource-id		[1..1]	[1..1]		The patient identifier attribute shall consist of two parts; the OID for the assigning authority and the identifier of the patient within that assigning authority. The value shall be formatted using the CX syntax. Shall always be the identity of the patient which the request applies to.	<p><u>HP usage:</u> Supported ID-types are National personal ID numbers (fødselsnummer og d-nummer)</p> <p><u>Citizen usage:</u> Supported ID-types are National personal ID numbers (fødselsnummer og d-nummer)</p> <pre><saml:Attribute Name="urn:oasis:names:tc:xacml:2.0:r esource:resource-id"></pre>

Name Attribute	National extension	Card: HP usage	Card: Citizen usage	Datatype	Original descriptions (from ITI TF-2b)	Norwegian National Extension
						<pre><saml:AttributeValue>11116642257^^^ &amp;2.16.578.1.12.4.1.4.1&amp;ISO </saml:AttributeValue> </saml:Attribute></pre>
SecurityLevel	Yes	[1..1]	[1..1]			<p>HP usage: Either national security level codes (1-4 where 4 is the highest and requires qualified certificates) or eIDAS (Low, substantial and High)</p> <p>Citizen usage: Either national security level codes (1-4 where 4 is the highest and requires qualified certificates) or eIDAS (Low, substantial and High)</p> <pre><saml:Attribute Name="SecurityLevel"> <saml:AttributeValue>4</saml:AttributeVa lue> </saml:Attribute></pre>
Scope	Yes	[1..1]	[1..1]			<p>HP usage: Data elements the logged in user has access to about the person being searched. Examples: critical info, journal documents. For XDS the value should always be: "journaldokumenter_helsepersonell"</p> <p>Citizen usage: Same as HP usage but with other values: kritiskinfo, egne dokumenter</p> <pre><saml:Attribute Name="Scope"></pre>

Name Attribute	National extension	Card: HP usage	Card: Citizen usage	Datatype	Original descriptions (from ITI TF-2b)	Norwegian National Extension
						<pre><saml:AttributeValue>journaldokumenter_helsepersonell </saml:AttributeValue> </saml:Attribute></pre>
client_id	Yes	[0..1]	[0..1]			<p><u>HP usage:</u> Client ID from requesting system (initating Document Consumer who received the issued SAML token)</p> <p><u>Citizen usage:</u> A client used by the citizen, for instance helsenor.no</p>

5 Annex - Example messages (not normative)

This annex includes XML examples for each IHE transaction profiled in this document. For each transaction, a request with a corresponding response example is included. Each request includes an ITI-40 (Provide X-user assertion). The ITI-40 is placed in the SOAP header of a request. An ITI-40 can be looked at as a security token and includes the OASIS Web Services Security (WSS) Header and a SAML 2.0 Assertion. You can find the ITI-40 inside a request as the "Security" XML attribute.

5.1 ITI-18 + ITI-40 Request

```
<?xml version="1.0" encoding="UTF-8"?>
<!-- Created with Liquid Technologies Online Tools 1.0 (https://www.liquid-technologies.com) -->
<s:Envelope xmlns:s="http://www.w3.org/2003/05/soap-envelope" xmlns:a="http://www.w3.org/2005/08/addressing" xmlns:u="http://docs.oasis-open.org/wss/2004/01/oasis-200401-wss-wssecurity-utility-1.0.xsd">
  <s:Header>
    <a:Action s:mustUnderstand="1">urn:ihe:iti:2007:RegistryStoredQuery</a:Action>
  </s:Header>
  <a:MessageID>urn:uuid:c6fda90e-a5ec-4f8d-aa1b-14802f4bf68d</a:MessageID>
  <a:ReplyTo>
    <a:Address>http://www.w3.org/2005/08/addressing/anonymous</a:Address>
  </a:ReplyTo>
  <a:To s:mustUnderstand="1">https://ttr1xds-reg01.test.drift.nhn.no/xca/xca-iti18</a:To>
  <o:Security xmlns:o="http://docs.oasis-open.org/wss/2004/01/oasis-200401-wss-wssecurity-secext-1.0.xsd" s:mustUnderstand="1">
    <u:Timestamp u:Id="_0">
      <u:Created>2019-05-10T07:18:03.673Z</u:Created>
      <u:Expires>2019-05-10T07:23:03.673Z</u:Expires>
    </u:Timestamp>
    <saml:Assertion xmlns:saml="urn:oasis:names:tc:SAML:2.0:assertion" ID="_70bab571-5e1f-4588-8379-f40bd9e6de1c" IssueInstant="2019-05-10T07:18:02.955Z" Version="2.0">
      <saml:Issuer>sikkerhet.helsenorge.no</saml:Issuer>
      <Signature xmlns="http://www.w3.org/2000/09/xmldsig#">
        <SignedInfo>
          <CanonicalizationMethod Algorithm="http://www.w3.org/2001/10/xml-exc-c14n#" />
          <SignatureMethod Algorithm="http://www.w3.org/2001/04/xmldsig-more#rsa-sha256" />
          <Reference URI="#_70bab571-5e1f-4588-8379-f40bd9e6de1c">
            <Transforms>
              <Transform Algorithm="http://www.w3.org/2000/09/xmldsig#enveloped-signature" />
              <Transform Algorithm="http://www.w3.org/2001/10/xml-exc-c14n#" />
            </Transforms>
          </Reference>
        </SignedInfo>
      </Signature>
    </saml:Assertion>
  </o:Security>
</s:Envelope>
```

```

        <DigestMethod Algorithm="http://www.w3.org/2001/04/xmlenc#sha256"
/>
        <DigestValue>v7fkRZ17NIkThj9lg3oY/RILg7uCYLihiLq7JIjzLeo=</DigestV
alue>
        </Reference>
        </SignedInfo>
        <SignatureValue>f2Miy+/0MGa0UnsFEwXhWQKLKYdMq2RwDp2DvmedKeI3sMifItgUhX
IA11QaHHobJ03QS/aHxGk4TZRx4n9BiBUVgELoV6JBfF/FAoyVrRQnfMugQZrin56Y1XPT46LTH03JmO
uEbwVZS2eD8Q/YPLVUzyGOFrSgz68XgrRqkgmre5Oja0rI1/BvUeNfBDFR1/zAGcGCzZv7B0FR1kZxlj
FKrT+P91Bp2wx9sy+9P/6z2dLt2YGcpKzRymvWNC31Tp/xLi+VLBTdpKCobqF2W8hE7NQmQPmo7TPFlc
8dnOpAXATB9qFOO5V/C9cUB4t/Td37o3mqiSMj3FoKAWiU5A==</SignatureValue>
        <KeyInfo>
        <X509Data>
        <X509Certificate>MIIFIzCCBAugAwIBAgILAU19LXLZ+viLGIWdQYJKoZIhvcNA
QELBQAwUTELMAkGA1UEBhMCTk8xHTAbBgNVBAoMFEJleXBhc3MgQVMtOTgzMTYzZmZlM3MwIQRVQDD
BpCdXlwYXNzIENsYXNzIDMgVGZzdDQgQ0EgMzAeFw0xNzA1MDgxMDUzMzdaFw0yMDA1MDgyMTU5MDBaM
IGIMQswCQYDVQGEwJOTzEhMB8GA1UECgwYRElSRUUtUT1JBVEVUIEZPUiBFLUhfTfNFMRSwGQYDVQLD
BjOzWwzZW5vcmdlLm5vIFRFRU1QxJTAjBgNVBAMHEhlnbHNlbn9yZ2Uubm8gU21ra2VyaGV0IFRFRU1QxE
jAQBGNVAUTCTkxNTkzMZE0OTCCASiWdQYJKoZIhvcNAQEBBQADggEPADCCAQoCggEBAO6CSeYXwt7O
nyfQ2XAPKFMoYU6F727IRrBjPsgZa16k9opcPqfx1OVEDsrjoBw88G1vhtpu5hEa8mSlH0y/ccsnD7v
hZ2q0TLPS51LzOXjfukt+0SpSV301alPAZ61+Qhgok6vi8LCXt0BBJIO3lahf6iTbwukMxwpcTzeKVhp
Lw9vU73yU++Mw2f91T6iW+62JP9NtSyaT7jJ5KpZkTGx2QFTHEFUA/PX12To6X1C6HqoKjgXzePZJE4D
69WbzwWXN93Nj713BTHA4ZRixISGDvL0NgSrbGXPP3PK1IZS8oKB0716JQaxeSuesyDnFPZpTGnE4p1/
CXFQ5gK1zkCAwEAAoCACIwggG+MAkGA1UdEwQCMAAwHwYDVR0jBBgwFoAUP671eAuSo3AgNV9a+vcko
FIB8EEwHQYDVR0OBBYEFBehpcMyRVShJxmIahVgtwTdPGOGMA4GA1UdDwEB/wQEAwIGQDAWBGNVHSAED
zANMAsGCWCEQgEaAQADAjCBuwYDVR0fBIGzMIgWMDegNaAzhjFodHRwOi8vY3JsLnRlc3Q0LmJleXBhc
3Mubm8vY3JsL0JQQ2xhc3MzVDRDQTMuY3JsMHWgc6Bxhm9sZGFwOi8vbGRhcC50ZXN0NC5idXlwYXNzL
m5vL2RjPUJleXBhc3MsZGM9Tk8sQ049QnV5cGFzcyUyMENsYXNzJTlWMyUyMFRlc3Q0JTlWQ0ElMjAzP
2N1cnRpZmljYXRlUmV2b2NhdG1vbKxpc3QwGwYoGCCsGAQUFBwEBBH4wFwIDA7BggrBgEFBQcwAYYvaHR0c
DovL29jc3AudGVzdDQuYnV5cGFzcy5ub3Y9vY3NwL0JQQ2xhc3MzVDRDQTMwPQYIKwYBBQUHMAKGMWh0d
HA6Ly9jcncudGVzdDQuYnV5cGFzcy5ub3Y9jcnQvQlBDbGFzcnUNENBM5jZlIwDQYJKoZIhvcNAQELB
QADggEBAB14W1eqo4LN70unW7jr6YVpDDdTMaZv4A9e8V2B7YRLKKzWqKNhwj+B4dE//h1Fi0uTbI877
BEC+WQqcXF7Vnfc3XeK4ySQqnIaX9XxfkJa8NzMojlz4Jwyk0r/aUjw652p1Ao720xvSIWjgJBaLqMXn
nLvTF2mhMBLarZ30MBpPcgRmcJgiZ5HslQnuGzmJK2/ByE9EC0AMczfdtHIVou3qy1wa5tXHGHBFiHyC
CGZcwteN1RizSC80J319t7INVW/piXVWRKL7NuOL4CqUoM/JPhVYwlv9DGKJgAC3V7Gk5sMqyjCThzlh
ZamOAJvjYhtveVz9DkppyQDvAYskc=</X509Certificate>
        </X509Data>
        </KeyInfo>
        </Signature>
        <saml:Subject>
        <saml:NameID SPProvidedID="29019900248">29019900248</saml:NameID>
        <saml:SubjectConfirmation Method="urn:oasis:names:tc:SAML:2.0:cm:beare
r" />
        </saml:Subject>
        <saml:Conditions NotBefore="2019-05-10T07:18:02.955Z" NotOnOrAfter="2019
-05-10T07:38:02.955Z">
        <saml:AudienceRestriction>
        <saml:Audience>https://xds-web.test.nhn.no</saml:Audience>
        </saml:AudienceRestriction>
        </saml:Conditions>
        <saml:AttributeStatement>
        <saml:Attribute Name="urn:oasis:names:tc:xspa:1.0:subject:subject-id">
        <saml:AttributeValue>Karoline Matre</saml:AttributeValue>
        </saml:Attribute>
        <saml:Attribute Name="urn:oasis:names:tc:xspa:1.0:subject:organization
">
        <saml:AttributeValue>Norsk Helsnett</saml:AttributeValue>
        </saml:Attribute>

```

```

    <saml:Attribute Name="urn:oasis:names:tc:xspa:1.0:subject:organization
-id">
      <saml:AttributeValue> <id xmlns="urn:hl7-org:v3" xsi:type="II" exten
sion="994598759" root="2.16.578.1.12.4.1.4.101" assigningAuthorityName="Brønnøys
undregistrene" displayable="false"/>
    </saml:AttributeValue>
  </saml:Attribute>
  <saml:Attribute Name="urn:ihe:iti:xca:2010:homeCommunityId">
    <saml:AttributeValue>urn:oid:2.16.578.1.12.4.1.7.1.2</saml:Attribute
Value>
  </saml:Attribute>
  <saml:Attribute Name="urn:oasis:names:tc:xspa:2.0:subject:npi">
    <saml:AttributeValue>29019900248</saml:AttributeValue>
  </saml:Attribute>
  <saml:Attribute Name="urn:ihe:iti:xua:2017:subject:provider-identifier
">
    <saml:AttributeValue><id xmlns="urn:hl7-org:v3" type="II" extension=
"29019900248" root="2.16.578.1.12.4.1.4.1" displayable="false" /></saml:Attribut
eValue>
  </saml:Attribute>
  <saml:Attribute Name="urn:oasis:names:tc:xspa:1.0:subject:purposeofuse
">
    <saml:AttributeValue><PurposeOfUse xmlns="urn:hl7-org:v3" type="CE"
code="13" codeSystem="1.0.14265.1" codeSystemName="ISO 14265 Classification of P
urposes for processing personal health information" displayName="Subject of care
uses"/></saml:AttributeValue>
  </saml:Attribute>
  <saml:Attribute Name="urn:oasis:names:tc:xacml:2.0:resource:resource-i
d">
    <saml:AttributeValue>29019900248^^^&amp;2.16.578.1.12.4.1.4.1&a
mp;ISO</saml:AttributeValue>
  </saml:Attribute>
  <saml:Attribute Name="SecurityLevel">
    <saml:AttributeValue>4</saml:AttributeValue>
  </saml:Attribute>
  <saml:Attribute Name="Scope">
    <saml:AttributeValue>innsynregisterbruk,innsynregisterinnhold,innsyn
pasientjournal</saml:AttributeValue>
  </saml:Attribute>
</saml:AttributeStatement>
<saml:AuthnStatement AuthnInstant="2019-05-10T07:18:02.955Z" SessionNotO
nOrAfter="2019-05-10T07:38:02.955Z">
  <saml:AuthnContext>
    <saml:AuthnContextClassRef>urn:oasis:names:tc:SAML:2.0:ac:classes:X5
09</saml:AuthnContextClassRef>
  </saml:AuthnContext>
</saml:AuthnStatement>
</saml:Assertion>
</o:Security>
</s:Header>
<s:Body xmlns:xsd="http://www.w3.org/2001/XMLSchema" xmlns:xsi="http://www.w3.
org/2001/XMLSchema-instance">
  <AdhocQueryRequest xmlns="urn:oasis:names:tc:ebxml-regrep:xsd:query:3.0">
    <ResponseOption returnType="LeafClass" returnComposedObjects="true" />
    <AdhocQuery xmlns="urn:oasis:names:tc:ebxml-regrep:xsd:rim:3.0" id="urn:uu
id:14d4debf-8f97-4251-9a74-a90016b0af0d">
      <Slot name="$XSDSDocumentEntryPatientId">
        <ValueList>

```

```

        <Value>'29019900248^^^&amp;2.16.578.1.12.4.1.4.1&amp;ISO'</Value>
    </ValueList>
</Slot>
<Slot name="$XDSDocumentEntryStatus">
    <ValueList>
        <Value>('urn:oasis:names:tc:ebxml-regrep:StatusType:Approved')</Value>
e>
    </ValueList>
</Slot>
<Slot name="$XDSDocumentEntryConfidentialityCode">
    <ValueList>
        <Value>('L^^2.16.840.1.113883.5.25')</Value>
        <Value>('M^^2.16.840.1.113883.5.25')</Value>
        <Value>('N^^2.16.840.1.113883.5.25')</Value>
        <Value>('U^^2.16.840.1.113883.5.25')</Value>
        <Value>('R^^2.16.840.1.113883.5.25')</Value>
    </ValueList>
</Slot>
</AdhocQuery>
</AdhocQueryRequest>
</s:Body>
</s:Envelope>

```

5.2 ITI-18 response

Note: The Security header is in the example included with `mustUnderstand="false"`. The Security header can also be fully omitted in the response.

```

<soap:Envelope xmlns:soap="http://www.w3.org/2003/05/soap-envelope">
  <soap:Header>
    <wsse:Security soap:mustUnderstand="false" xmlns:wsse="http://docs.oasis-
-open.org/wss/2004/01/oasis-200401-wss-wssecurity-secext-1.0.xsd" xmlns:wsu=
"http://docs.oasis-open.org/wss/2004/01/oasis-200401-wss-wssecurity-utility-
1.0.xsd">
      <wsu:Timestamp wsu:Id="TS-97">
        <wsu:Created>2019-05-10T07:18:03.896Z</wsu:Created>
        <wsu:Expires>2019-05-10T07:23:03.896Z</wsu:Expires>
      </wsu:Timestamp>
    </wsse:Security>
    <Action xmlns="http://www.w3.org/2005/08/addressing">urn:ihe:iti:2007:Re
gistryStoredQueryResponse</Action>
    <MessageID xmlns="http://www.w3.org/2005/08/addressing">urn:uuid:35b27b8
5-7965-4eaa-9f15-dddfa9d821bc</MessageID>
    <To xmlns="http://www.w3.org/2005/08/addressing">http://www.w3.org/2005/
08/addressing/anonymous</To>
    <RelatesTo xmlns="http://www.w3.org/2005/08/addressing">urn:uuid:c6fda90
e-a5ec-4f8d-aa1b-14802f4bf68d</RelatesTo>
  </soap:Header>
  <soap:Body>
    <ns4:AdhocQueryResponse xmlns:ns6="urn:oasis:names:tc:ebxml-regrep:xsd:1
cm:3.0" xmlns:ns5="urn:ihe:iti:xds-b:2007" xmlns:ns4="urn:oasis:names:tc:ebx
ml-regrep:xsd:query:3.0" xmlns:ns3="urn:oasis:names:tc:ebxml-regrep:xsd:rs:3
.0" xmlns:ns2="urn:oasis:names:tc:ebxml-regrep:xsd:rim:3.0" status="urn:asi
s:names:tc:ebxml-regrep:ResponseStatusType:Success">

```

```

<ns2:RegistryObjectList>
  <ns2:ExtrinsicObject mimeType="text/rtf" objectType="urn:uuid:7edca8
2f-054d-47f2-a032-9b2a5b5186c1" status="urn:oasis:names:tc:ebxml-regrep:Stat
usType:Approved" id="urn:uuid:03df3d45-0000-0000-0000-000000000000" home="2.
16.578.1.12.4.1.2.5604">
    <ns2:Slot name="creationTime">
      <ns2:ValueList>
        <ns2:Value>20171126174700</ns2:Value>
      </ns2:ValueList>
    </ns2:Slot>
    <ns2:Slot name="hash">
      <ns2:ValueList>
        <ns2:Value>da39a3ee5e6b4b0d3255bfe95601890afd80709</ns2:Value
>
      </ns2:ValueList>
    </ns2:Slot>
    <ns2:Slot name="languageCode">
      <ns2:ValueList>
        <ns2:Value>no</ns2:Value>
      </ns2:ValueList>
    </ns2:Slot>
    <ns2:Slot name="repositoryUniqueId">
      <ns2:ValueList>
        <ns2:Value>2.16.578.1.12.4.3.1.4.20.1</ns2:Value>
      </ns2:ValueList>
    </ns2:Slot>
    <ns2:Slot name="size">
      <ns2:ValueList>
        <ns2:Value>0</ns2:Value>
      </ns2:ValueList>
    </ns2:Slot>
    <ns2:Slot name="legalAuthenticator">
      <ns2:ValueList>
        <ns2:Value>RILIN^Lin^Rita^^^^^^&2.16.578.1.12.4.1.4.4&
ISO</ns2:Value>
      </ns2:ValueList>
    </ns2:Slot>
    <ns2:Slot name="sourcePatientId">
      <ns2:ValueList>
        <ns2:Value>29019900248^^^&2.16.578.1.12.4.1.4.1&ISO</n
s2:Value>
      </ns2:ValueList>
    </ns2:Slot>
    <ns2:Slot name="sourcePatientInfo">
      <ns2:ValueList>
        <ns2:Value>PID-5|Matre^Karoline Testpatient</ns2:Value>
        <ns2:Value>PID-7|19990129</ns2:Value>
        <ns2:Value>PID-8|F</ns2:Value>
      </ns2:ValueList>
    </ns2:Slot>
    <ns2:Name>
      <ns2:LocalizedString xml:lang="en-US" charset="UTF-8" value="Epi
krise - mor" />
    </ns2:Name>
    <ns2:Classification classificationScheme="urn:uuid:93606bcf-9494-4
3ec-9b4e-a7748d1a838d" classifiedObject="urn:uuid:03df3d45-0000-0000-0000-00
0000000000" nodeRepresentation="" id="urn:uuid:9a1e1cc4-7ed8-41ff-911e-2d826
6fcafdd">

```

```

    <ns2:Slot name="authorPerson">
      <ns2:ValueList>
        <ns2:Value>RILIN^Lin^Rita^^^^^&2.16.578.1.12.4.1.4.4&am
p;ISO</ns2:Value>
      </ns2:ValueList>
    </ns2:Slot>
    <ns2:Slot name="authorInstitution">
      <ns2:ValueList>
        <ns2:Value>Kvinneklubben^^^^^&2.16.578.1.12.4.1.4.102&
amp;ISO^^^^108048</ns2:Value>
        <ns2:Value>Sykehuset Østfold HF(PK2b 02.10.2018)</ns2:Value>
        <ns2:Value>Sykehuset Østfold HF^^^^^&2.16.578.1.12.4.1.4
.101&ISO^^^^983971768</ns2:Value>
      </ns2:ValueList>
    </ns2:Slot>
    <ns2:Slot name="authorRole">
      <ns2:ValueList>
        <ns2:Value>Partus-forvalter</ns2:Value>
      </ns2:ValueList>
    </ns2:Slot>
  </ns2:Classification>
  <ns2:Classification classificationScheme="urn:uuid:41a5887f-8865-4
c09-adf7-e362475b143a" classifiedObject="urn:uuid:03df3d45-0000-0000-0000-00
0000000000" nodeRepresentation="A00-1" id="urn:uuid:79d2dad8-64e7-4170-b47f-
8eb929424c0f">
    <ns2:Slot name="codingScheme">
      <ns2:ValueList>
        <ns2:Value>2.16.578.1.12.4.1.1.9602</ns2:Value>
      </ns2:ValueList>
    </ns2:Slot>
    <ns2:Name>
      <ns2:LocalizedString xml:lang="en-US" charset="UTF-8" value="E
pikriser og sammenfatninger" />
    </ns2:Name>
  </ns2:Classification>
  <ns2:Classification classificationScheme="urn:uuid:a09d5840-386c-4
6f2-b5ad-9c3699a4309d" classifiedObject="urn:uuid:03df3d45-0000-0000-0000-00
0000000000" nodeRepresentation="urn:no:ehelse:document:text" id="urn:uuid:14
6890e1-6e9d-40f5-880f-8c3659ca50d5">
    <ns2:Slot name="codingScheme">
      <ns2:ValueList>
        <ns2:Value>FormatCodes</ns2:Value>
      </ns2:ValueList>
    </ns2:Slot>
    <ns2:Name>
      <ns2:LocalizedString xml:lang="en-US" charset="UTF-8" value="u
rn:no:ehelse:document:text" />
    </ns2:Name>
  </ns2:Classification>
  <ns2:Classification classificationScheme="urn:uuid:f33fb8ac-18af-4
2cc-ae0e-ed0b0bdb91e1" classifiedObject="urn:uuid:03df3d45-0000-0000-0000-00
0000000000" nodeRepresentation="86.101" id="urn:uuid:e0e58814-9cf1-45d1-aea5
-8cc9f4956306">
    <ns2:Slot name="codingScheme">
      <ns2:ValueList>
        <ns2:Value>2.16.578.1.12.4.1.1.1303</ns2:Value>
      </ns2:ValueList>
    </ns2:Slot>

```



```

        <ns2:Name>
          <ns2:LocalizedString xml:lang="en-US" charset="UTF-8" value="A
lminnelige somatiske sykehus" />
        </ns2:Name>
      </ns2:Classification>
      <ns2:Classification classificationScheme="urn:uuid:ccccf5598-8b07-4
b77-a05e-ae952c785ead" classifiedObject="urn:uuid:03df3d45-0000-0000-0000-00
0000000000" nodeRepresentation="Ukjent" id="urn:uuid:056c614e-0480-4b53-a78f
-31709ebf77d4">
        <ns2:Slot name="codingScheme">
          <ns2:ValueList>
            <ns2:Value>Ukjent</ns2:Value>
          </ns2:ValueList>
        </ns2:Slot>
        <ns2:Name>
          <ns2:LocalizedString xml:lang="en-US" charset="UTF-8" value="U
kjent" />
        </ns2:Name>
      </ns2:Classification>
      <ns2:Classification classificationScheme="urn:uuid:f0306f51-975f-4
34e-a61c-c59651d33983" classifiedObject="urn:uuid:03df3d45-0000-0000-0000-00
0000000000" nodeRepresentation="A03-2" id="urn:uuid:5a5ced1d-0c59-4f1f-8833-
2758ab811f35">
        <ns2:Slot name="codingScheme">
          <ns2:ValueList>
            <ns2:Value>2.16.578.1.12.4.1.1.9602</ns2:Value>
          </ns2:ValueList>
        </ns2:Slot>
        <ns2:Name>
          <ns2:LocalizedString xml:lang="en-US" charset="UTF-8" value="E
pikrise" />
        </ns2:Name>
      </ns2:Classification>
      <ns2:Classification classificationScheme="urn:uuid:f4f85eac-e6cb-4
883-b524-f2705394840f" classifiedObject="urn:uuid:03df3d45-0000-0000-0000-00
0000000000" nodeRepresentation="N" id="urn:uuid:4ad902b0-1845-4a3e-935f-8641
f40432b2">
        <ns2:Slot name="codingScheme">
          <ns2:ValueList>
            <ns2:Value>2.16.840.1.113883.5.25</ns2:Value>
          </ns2:ValueList>
        </ns2:Slot>
        <ns2:Name>
          <ns2:LocalizedString xml:lang="en-US" charset="UTF-8" value="n
ormal" />
        </ns2:Name>
      </ns2:Classification>
      <ns2:ExternalIdentifier registryObject="urn:uuid:03df3d45-0000-000
0-0000-000000000000" identificationScheme="urn:uuid:58a6f841-87b3-4a3e-92fd-
a8ffeff98427" value="29019900248^^^&2.16.578.1.12.4.1.4.1&ISO" id="u
rn:uuid:1420a0dd-c918-41bf-ad87-8fcad7f32a24">
        <ns2:Name>
          <ns2:LocalizedString value="XDSDocumentEntry.patientId" />
        </ns2:Name>
      </ns2:ExternalIdentifier>
      <ns2:ExternalIdentifier registryObject="urn:uuid:03df3d45-0000-000
0-0000-000000000000" identificationScheme="urn:uuid:2e82c1f6-a085-4c72-9da3-

```

```

8640a32e42ab" value="^64961861" id="urn:uuid:2c751a71-d285-466f-9998-9f08b22
1e1a1">
    <ns2:Name>
        <ns2:LocalizedString value="XSDDocumentEntry.uniqueId" />
    </ns2:Name>
</ns2:ExternalIdentifier>
</ns2:ExtrinsicObject>
<ns2:ExtrinsicObject mimeType="text/rtf" objectType="urn:uuid:7edca8
2f-054d-47f2-a032-9b2a5b5186c1" status="urn:oasis:names:tc:ebxml-regrep:Stat
usType:Approved" id="urn:uuid:03df3d1b-0000-0000-0000-000000000000" home="2.
16.578.1.12.4.1.2.5604">
    <ns2:Slot name="creationTime">
        <ns2:ValueList>
            <ns2:Value>20171126174800</ns2:Value>
        </ns2:ValueList>
    </ns2:Slot>
    <ns2:Slot name="hash">
        <ns2:ValueList>
            <ns2:Value>da39a3ee5e6b4b0d3255bfe95601890afd80709</ns2:Value
>
        </ns2:ValueList>
    </ns2:Slot>
    <ns2:Slot name="languageCode">
        <ns2:ValueList>
            <ns2:Value>no</ns2:Value>
        </ns2:ValueList>
    </ns2:Slot>
    <ns2:Slot name="repositoryUniqueId">
        <ns2:ValueList>
            <ns2:Value>2.16.578.1.12.4.3.1.4.20.1</ns2:Value>
        </ns2:ValueList>
    </ns2:Slot>
    <ns2:Slot name="size">
        <ns2:ValueList>
            <ns2:Value>0</ns2:Value>
        </ns2:ValueList>
    </ns2:Slot>
    <ns2:Slot name="legalAuthenticator">
        <ns2:ValueList>
            <ns2:Value>RILIN^Lin^Rita^^^^^^&2.16.578.1.12.4.1.4.4&
ISO</ns2:Value>
        </ns2:ValueList>
    </ns2:Slot>
    <ns2:Slot name="sourcePatientId">
        <ns2:ValueList>
            <ns2:Value>29019900248^^^&2.16.578.1.12.4.1.4.1&ISO</n
s2:Value>
        </ns2:ValueList>
    </ns2:Slot>
    <ns2:Slot name="sourcePatientInfo">
        <ns2:ValueList>
            <ns2:Value>PID-5|Matre^Karoline Testpatient</ns2:Value>
            <ns2:Value>PID-7|19990129</ns2:Value>
            <ns2:Value>PID-8|F</ns2:Value>
        </ns2:ValueList>
    </ns2:Slot>
</ns2:Name>

```

```

        <ns2:LocalizedString xml:lang="en-US" charset="UTF-8" value="IKK
E SIGNERT Epikrise - mor" />
    </ns2:Name>
    <ns2:Classification classificationScheme="urn:uuid:93606bcf-9494-4
3ec-9b4e-a7748d1a838d" classifiedObject="urn:uuid:03df3d1b-0000-0000-0000-00
0000000000" nodeRepresentation="" id="urn:uuid:91b3a6e8-629f-495e-9dd2-8135d
b140d5d">
        <ns2:Slot name="authorPerson">
            <ns2:ValueList>
                <ns2:Value>RILIN^Lin^Rita^^^^^&2.16.578.1.12.4.1.4.4&am
p;ISO</ns2:Value>
            </ns2:ValueList>
        </ns2:Slot>
        <ns2:Slot name="authorInstitution">
            <ns2:ValueList>
                <ns2:Value>Kvinnekliviken^^^^^&2.16.578.1.12.4.1.4.102&
amp;ISO^^^^108048</ns2:Value>
                <ns2:Value>Sykehuset Østfold HF(PK2b 02.10.2018)</ns2:Value>
                <ns2:Value>Sykehuset Østfold HF^^^^^&2.16.578.1.12.4.1.4
.101&ISO^^^^983971768</ns2:Value>
            </ns2:ValueList>
        </ns2:Slot>
        <ns2:Slot name="authorRole">
            <ns2:ValueList>
                <ns2:Value>Partus-forvalter</ns2:Value>
            </ns2:ValueList>
        </ns2:Slot>
    </ns2:Classification>
    <ns2:Classification classificationScheme="urn:uuid:41a5887f-8865-4
c09-adf7-e362475b143a" classifiedObject="urn:uuid:03df3d1b-0000-0000-0000-00
0000000000" nodeRepresentation="A00-1" id="urn:uuid:18ae6261-feec-4eac-8907-
efd299a47bdf">
        <ns2:Slot name="codingScheme">
            <ns2:ValueList>
                <ns2:Value>2.16.578.1.12.4.1.1.9602</ns2:Value>
            </ns2:ValueList>
        </ns2:Slot>
        <ns2:Name>
            <ns2:LocalizedString xml:lang="en-US" charset="UTF-8" value="E
pikriser og sammenfatninger" />
        </ns2:Name>
    </ns2:Classification>
    <ns2:Classification classificationScheme="urn:uuid:a09d5840-386c-4
6f2-b5ad-9c3699a4309d" classifiedObject="urn:uuid:03df3d1b-0000-0000-0000-00
0000000000" nodeRepresentation="urn:no:ehelse:document:text" id="urn:uuid:26
4cf9fa-d1a8-465b-b571-163acaf515b2">
        <ns2:Slot name="codingScheme">
            <ns2:ValueList>
                <ns2:Value>FormatCodes</ns2:Value>
            </ns2:ValueList>
        </ns2:Slot>
        <ns2:Name>
            <ns2:LocalizedString xml:lang="en-US" charset="UTF-8" value="u
rn:no:ehelse:document:text" />
        </ns2:Name>
    </ns2:Classification>
    <ns2:Classification classificationScheme="urn:uuid:f33fb8ac-18af-4
2cc-ae0e-ed0b0bdb91e1" classifiedObject="urn:uuid:03df3d1b-0000-0000-0000-00

```

```

0000000000" nodeRepresentation="86.101" id="urn:uuid:eaaff5eb-0e4a-46b9-8aba
-e2ac0270048b">
  <ns2:Slot name="codingScheme">
    <ns2:ValueList>
      <ns2:Value>2.16.578.1.12.4.1.1.1303</ns2:Value>
    </ns2:ValueList>
  </ns2:Slot>
  <ns2:Name>
    <ns2:LocalizedString xml:lang="en-US" charset="UTF-8" value="A
lminnelige somatiske sykehus" />
  </ns2:Name>
</ns2:Classification>
<ns2:Classification classificationScheme="urn:uuid:cccf5598-8b07-4
b77-a05e-ae952c785ead" classifiedObject="urn:uuid:03df3d1b-0000-0000-0000-00
0000000000" nodeRepresentation="Ukjent" id="urn:uuid:d8a2ef06-87ab-4eb3-8bbf
-2b9682fb42f5">
  <ns2:Slot name="codingScheme">
    <ns2:ValueList>
      <ns2:Value>Ukjent</ns2:Value>
    </ns2:ValueList>
  </ns2:Slot>
  <ns2:Name>
    <ns2:LocalizedString xml:lang="en-US" charset="UTF-8" value="U
kjent" />
  </ns2:Name>
</ns2:Classification>
<ns2:Classification classificationScheme="urn:uuid:f0306f51-975f-4
34e-a61c-c59651d33983" classifiedObject="urn:uuid:03df3d1b-0000-0000-0000-00
0000000000" nodeRepresentation="A03-2" id="urn:uuid:5e9a2b2b-c03d-485b-9c1f-
dc080ae41d28">
  <ns2:Slot name="codingScheme">
    <ns2:ValueList>
      <ns2:Value>2.16.578.1.12.4.1.1.9602</ns2:Value>
    </ns2:ValueList>
  </ns2:Slot>
  <ns2:Name>
    <ns2:LocalizedString xml:lang="en-US" charset="UTF-8" value="E
pikrise" />
  </ns2:Name>
</ns2:Classification>
<ns2:Classification classificationScheme="urn:uuid:f4f85eac-e6cb-4
883-b524-f2705394840f" classifiedObject="urn:uuid:03df3d1b-0000-0000-0000-00
0000000000" nodeRepresentation="N" id="urn:uuid:aa3f6928-b872-455b-aadd-ca35
90d48d19">
  <ns2:Slot name="codingScheme">
    <ns2:ValueList>
      <ns2:Value>2.16.840.1.113883.5.25</ns2:Value>
    </ns2:ValueList>
  </ns2:Slot>
  <ns2:Name>
    <ns2:LocalizedString xml:lang="en-US" charset="UTF-8" value="n
ormal" />
  </ns2:Name>
</ns2:Classification>
<ns2:ExternalIdentifier registryObject="urn:uuid:03df3d1b-0000-000
0-0000-000000000000" identificationScheme="urn:uuid:58a6f841-87b3-4a3e-92fd-
a8ffeff98427" value="29019900248^^^&2.16.578.1.12.4.1.4.1&ISO" id="u
rn:uuid:153c3de3-0767-4322-8bf3-906e26fdc8f2">

```

```

        <ns2:Name>
          <ns2:LocalizedString value="XSDDocumentEntry.patientId" />
        </ns2:Name>
      </ns2:ExternalIdentifier>
      <ns2:ExternalIdentifier registryObject="urn:uuid:03df3d1b-0000-0000-0000-000000000000" identificationScheme="urn:uuid:2e82c1f6-a085-4c72-9da3-8640a32e42ab" value="^64961819" id="urn:uuid:bfc7bd55-0486-4c91-9991-8e0ecde a381c">
        <ns2:Name>
          <ns2:LocalizedString value="XSDDocumentEntry.uniqueId" />
        </ns2:Name>
      </ns2:ExternalIdentifier>
    </ns2:ExtrinsicObject>
  </ns2:RegistryObjectList>
</ns4:AdhocQueryResponse>
</soap:Body>
</soap:Envelope>

```

5.3 ITI-43 + ITI 40 request

```

<!-- Created with Liquid Technologies Online Tools 1.0 (https://www.liquid-technologies.com) -->
<s:Envelope xmlns:s="http://www.w3.org/2003/05/soap-envelope" xmlns:a="http://www.w3.org/2005/08/addressing" xmlns:u="http://docs.oasis-open.org/wss/2004/01/oasis-200401-wss-wssecurity-utility-1.0.xsd">
  <s:Header>
    <a:Action s:mustUnderstand="1">urn:ihe:iti:2007:RetrieveDocumentSet</a:Action>
    <a:MessageID>urn:uuid:a2b2a7de-0d0c-4dbc-b343-85ac02a745c5</a:MessageID>
    <a:ReplyTo>
      <a:Address>http://www.w3.org/2005/08/addressing/anonymous</a:Address>
    </a:ReplyTo>
    <a:To s:mustUnderstand="1">https://ttr1xds-reg01.test.drift.nhn.no/xca/xca-iti43</a:To>
    <o:Security s:mustUnderstand="1" xmlns:o="http://docs.oasis-open.org/wss/2004/01/oasis-200401-wss-wssecurity-secext-1.0.xsd">
      <u:Timestamp u:Id="_0">
        <u:Created>2019-05-10T07:22:56.765Z</u:Created>
        <u:Expires>2019-05-10T07:27:56.765Z</u:Expires>
      </u:Timestamp>
      <saml:Assertion ID="_d72f1016-7438-4754-ba93-e9cad659819c" IssueInstant="2019-05-10T07:22:56.533Z" Version="2.0" xmlns:saml="urn:oasis:names:tc:SAAML:2.0:assertion">
        <saml:Issuer>sikkerhet.helsenorge.no</saml:Issuer>
        <Signature xmlns="http://www.w3.org/2000/09/xmldsig#">
          <SignedInfo>
            <CanonicalizationMethod Algorithm="http://www.w3.org/2001/10/xml-exc-c14n#" />
            <SignatureMethod Algorithm="http://www.w3.org/2001/04/xmldsig-more#rsa-sha256" />
            <Reference URI="#_d72f1016-7438-4754-ba93-e9cad659819c">
              <Transforms>
                <Transform Algorithm="http://www.w3.org/2000/09/xmldsig#enveloped-signature" />

```

```

        <Transform Algorithm="http://www.w3.org/2001/10/xml-exc-c14n
#" />
    </Transforms>
    <DigestMethod Algorithm="http://www.w3.org/2001/04/xmlenc#sha2
56" />
        <DigestValue>Kj7/8RM1IspD8CDuC5R2du/Cm8zWOVDtgav9v+VhURs=</Dig
estValue>
    </Reference>
</SignedInfo>
    <SignatureValue>vyKykJtLITxsnXWpgcVfJd78WzQG7o118LmpyZGoNyL+L43wJo
woJL54BBzDpZMewDVXzumTVxjBiJelEC7+xQQzQkgt1J2MiDxFbIXOMkT3Q+Hv+NX1PZ4Dr0Wbt5
DP5TsKn4os98zpTL5vkyf+xjtQekKjJbbIu4n3zQLITCpPcG2Ippqu07n89mUvC8Xp8yH85vdr3r
ILzkqHtgYzSvMICvqGGt6+npzPDKFn2pJtRUgq7zLLaidT+thgJaDQYjthkO3dw/Jkkjz9X3CBkD
yPohgqwlpv6EwRLYAmkypAJYJWRLPKHsUhHrXfBLbmL9v3zFtF2nD5+WWwE9pGXA==</Signatur
eValue>
    <KeyInfo>
        <X509Data>
            <X509Certificate>MIIFIzCCBAugAwIBAgILAU19LXlZ+viLGWIwDQYJKoZIh
vcNAQELBQAwUTELMAkGA1UEBhMCTk8xHTAbBgNVBAoMFEJleXBhc3MgQVMtOTgzMTYzMzI3MSMwI
QYDVQQDBBpCdXlwYXNzIENsYXNzIDMgVGVzdDQgQ0EgMzAeFw0xNzA1MDgxMDUzMzdaFw0yMDA1M
DgyMTU5MDBaMIGIMQswCQYDVQQGEWJOTzEhMB8GA1UECgwYRElSRUtUT1JBVEVUIEZPUiBFLUhFT
FNFMRswGQYDVQQQLDBJoZWxzZW5vcmdlLm5vIFRFRU1QxJTAjBgNVBAMMHhbnl9yZ2Uubm8gU
2lra2VyaGV0IFRFRU1QxYjAQBgNVBAUTCTkxNTkzMzE0OTCCASIwDQYJKoZIhvcNAQEBBQADggEPA
DCCAQoCggEBAO6CSeYwxt7OnyfQ2XAPKFMoYU6F727IRrrBjpSgZa16k9opcPqfx1OVEDsrjoBw
88G1vhtpu5hEa8mS1H0y/ccsnD7vhZ2q0TLPS51LzOXjfukt+0SpSV30lalPAZ61+Qhgok6vi8LC
Xt0BBJIO3lahf6iTbwukMxwpcTzeKVhpLw9vU73yU++Mw2f91T6iW+62JP9NtSyaT7jJ5KpZkTGx
2QFTHEFUA/PX12To6X1C6HqoKjgXzePZJE4D69WbzwWXN93Nj713BTHA4ZRixISGDvL0NgSrbGXP
P3PK1IZS8oKB0716JQaxeSuesyDnFPZpTgnE4pl/CXFQ5gKlzkCAwEAaAOCACIwggG+MAkGA1UdE
wQCAAwHwYDVR0jBBgwFoAUP671eAuSo3AgNV9a+vckoFIB8EEwHQYDVR0OBBYEFBehpcMyRVShJ
xmIahVgtwTdPGOGMA4GA1UdDwEB/wQEAwIGQDAWBgNVHSAEDzANMASGCWCEQgEaAQADAjCBuYDV
R0fBIGzMIGwMDEgNaAzhjFodHRwOi8vY3JsLnRlc3Q0LmJleXBhc3Mubm8vY3JsL0JQQ2xhc3MzV
DRDQTMuY3JsMHwgc6Bxhm9sZGFwOi8vbGRhcC50ZXN0NC5idXlwYXNzLm5vL2RjPUJleXBhc3MsZ
GM9Tk8sQ049QnV5cGFzcyUyMENsYXNzJTlwMyUyMFRlc3Q0JTlwQ0ElmJAzP2NlcnRpZmljYXRlU
mV2b2NhdG1vbXxpc3QwgYoGCCsGAQUFBwEBB4wfDA7BggrBgEFBQcwAYYvaHR0cDovL29jc3Aud
GVzdDQuYnV5cGFzcy5uby9vY3NwL0JQQ2xhc3MzVDRDQTMwPQYIKwYBBQUHMAKGMWh0dHA6Ly9j
c nQu dGVzdDQuYnV5cGFzcy5uby9jcnQvQlBDbGFzcnUNENBMy5jZXIwDQYJKoZIhvcNAQELBQADg
gEBAB14Wleq4LN70unW7jr6YVPDDdTMAzV4A9e8V2B7YRLKkzWqKNhwj+B4dE//hlFi0uTbI877
BEC+WQqcXF7VNfC3XeK4ySQqnIaX9XxfkJa8NzMojlz4Jwyk0r/aUjw652p1Ao72OxvSIWjgJBaL
qMXnnLvTF2mhMBLarZ30MBpPcgRmcJgiZ5Hs1QnuGzmJK2/ByE9EC0AMczfdtHIVou3qy1wa5tXH
GhBFiHyCCGZcwteN1RizSC80J319t7INVW/piXVWRKL7NuOL4CqUoM/JPhVYwlv9DGKJgAC3V7Gk
5sMqyjCThz1HZamOAJvjYhtveVz9DkppyGQDvAyskc=</X509Certificate>
        </X509Data>
    </KeyInfo>
</Signature>
<saml:Subject>
    <saml:NameID SPPprovidedID="29019900248">29019900248</saml:NameID>
    <saml:SubjectConfirmation Method="urn:oasis:names:tc:SAML:2.0:cm:b
earer" />
</saml:Subject>
    <saml:Conditions NotBefore="2019-05-10T07:22:56.533Z" NotOnOrAfter="
2019-05-10T07:42:56.533Z">
        <saml:AudienceRestriction>
            <saml:Audience>https://xds-web.test.nhn.no/</saml:Audience>
        </saml:AudienceRestriction>
    </saml:Conditions>
    <saml:AttributeStatement>
        <saml:Attribute Name="urn:oasis:names:tc:xspa:1.0:subject:subject-
id">

```

```

        <saml:AttributeValue>Karoline Matre</saml:AttributeValue>
    </saml:Attribute>
    <saml:Attribute Name="urn:oasis:names:tc:xspa:1.0:subject:organiza
tion">
        <saml:AttributeValue>Norsk Helsenett</saml:AttributeValue>
    </saml:Attribute>
    <saml:Attribute Name="urn:oasis:names:tc:xspa:1.0:subject:organiza
tion-id">
        <saml:AttributeValue> <id xmlns="urn:hl7-org:v3" xsi:type="II" ext
ension="994598759" root="2.16.578.1.12.4.1.4.101" assigningAuthorityName="Br
ønnøysundregistrene" displayable="false"/>
    </saml:AttributeValue>
    </saml:Attribute>
    <saml:Attribute Name="urn:ihe:iti:xca:2010:homeCommunityId">
        <saml:AttributeValue>urn:oid:2.16.578.1.12.4.1.7.1.2</saml:Attri
buteValue>
    </saml:Attribute>
    <saml:Attribute Name="urn:oasis:names:tc:xspa:2.0:subject:npi">
        <saml:AttributeValue>29019900248</saml:AttributeValue>
    </saml:Attribute>
    <saml:Attribute Name="urn:ihe:iti:xua:2017:subject:provider-identi
fier">
        <saml:AttributeValue><id xmlns="urn:hl7-org:v3" type="II" extens
ion="29019900248" root="2.16.578.1.12.4.1.4.1" displayable="false" /></saml:
AttributeValue>
    </saml:Attribute>
    <saml:Attribute Name="urn:oasis:names:tc:xspa:1.0:subject:purposeo
fuse">
        <saml:AttributeValue><PurposeOfUse xmlns="urn:hl7-org:v3" type="
CE" code="13" codeSystem="1.0.14265.1" codeSystemName="ISO 14265 Classificat
ion of Purposes for processing personal health information" displayName="Sub
ject of care uses"/></saml:AttributeValue>
    </saml:Attribute>
    <saml:Attribute Name="urn:oasis:names:tc:xacml:2.0:resource:reso
urce-id">
        <saml:AttributeValue>29019900248^^^&amp; amp; 2.16.578.1.12.4.1.4.1&amp; amp; IS
O</saml:AttributeValue>
    </saml:Attribute>
    <saml:Attribute Name="SecurityLevel">
        <saml:AttributeValue>4</saml:AttributeValue>
    </saml:Attribute>
    <saml:Attribute Name="Scope">
        <saml:AttributeValue>innsynregisterbruk,innsynregisterinnhold,in
nsynspasientjournal</saml:AttributeValue>
    </saml:Attribute>
</saml:AttributeStatement>
    <saml:AuthnStatement AuthnInstant="2019-05-10T07:22:56.549Z" Session
NotOnOrAfter="2019-05-10T07:42:56.549Z">
        <saml:AuthnContext>
            <saml:AuthnContextClassRef>urn:oasis:names:tc:SAML:2.0:ac:classe
s:X509</saml:AuthnContextClassRef>
        </saml:AuthnContext>
    </saml:AuthnStatement>
</saml:Assertion>
</o:Security>
</s:Header>
<s:Body xmlns:xsi="http://www.w3.org/2001/XMLSchema-instance" xmlns:xsd="h
ttp://www.w3.org/2001/XMLSchema">

```

```

<RetrieveDocumentSetRequest xmlns="urn:ihe:iti:xds-b:2007">
  <DocumentRequest>
    <HomeCommunityId>2.16.578.1.12.4.1.2.5604</HomeCommunityId>
    <RepositoryUniqueId>2.16.578.1.12.4.3.1.5.20.1</RepositoryUniqueId>
    <DocumentUniqueId>^105085430</DocumentUniqueId>
  </DocumentRequest>
</RetrieveDocumentSetRequest>
</s:Body>
</s:Envelope>

```

5.4 ITI-43 response

Note: The Security header is in the example included with mustUnderstand="false". The Security header can also be fully omitted in the response.

```

Encoding: UTF-8
Content-Type: multipart/related; type="application/xop+xml"; boundary="uuid:84be98b6-2aec-415f-b691-a8e47f9f3b2d"; start="<root.message@cxf.apache.org>"
; start-info="application/soap+xml"
Headers: {}
Payload: --uuid:84be98b6-2aec-415f-b691-a8e47f9f3b2d
Content-Type: application/xop+xml; charset=UTF-8; type="application/soap+xml"
;
Content-Transfer-Encoding: binary
Content-ID: <root.message@cxf.apache.org>

<soap:Envelope xmlns:soap="http://www.w3.org/2003/05/soap-envelope">
  <soap:Header>
    <o:Security soap:mustUnderstand="false" xmlns:o="http://docs.oasis-open.org/wss/2004/01/oasis-200401-wss-wssecurity-secext-1.0.xsd" xmlns:s="http://www.w3.org/2003/05/soap-envelope">
      <u:Timestamp xmlns:u="http://docs.oasis-open.org/wss/2004/01/oasis-200401-wss-wssecurity-utility-1.0.xsd" u:Id="_0">
        <u:Created>2019-05-10T07:22:58.977Z</u:Created>
        <u:Expires>2019-05-10T07:27:58.977Z</u:Expires>
      </u:Timestamp>
    </o:Security>
    <Action xmlns="http://www.w3.org/2005/08/addressing">urn:ihe:iti:2007:RetrieveDocumentSetResponse</Action>
    <MessageID xmlns="http://www.w3.org/2005/08/addressing">urn:uuid:02d9e81f-f6ee-42df-b264-f70cdae5c706</MessageID>
    <To xmlns="http://www.w3.org/2005/08/addressing">http://www.w3.org/2005/08/addressing/anonymous</To>
    <RelatesTo xmlns="http://www.w3.org/2005/08/addressing">urn:uuid:a2b2a7de-0d0c-4dbc-b343-85ac02a745c5</RelatesTo>
  </soap:Header>
  <soap:Body>
    <ns2:RetrieveDocumentSetResponse xmlns:ns6="urn:oasis:names:tc:ebxml-regrep:xsd:lcm:3.0" xmlns:ns5="urn:oasis:names:tc:ebxml-regrep:xsd:query:3.0" xmlns:ns4="urn:oasis:names:tc:ebxml-regrep:xsd:rs:3.0" xmlns:ns3="urn:oasis:names:tc:ebxml-regrep:xsd:rim:3.0" xmlns:ns2="urn:ihe:iti:xds-b:2007">

```



```

    <ns4:RegistryResponse status="urn:oasis:names:tc:ebxml-regrep:Response
    StatusType:Success" />
    <ns2:DocumentResponse>
      <ns2:HomeCommunityId>2.16.578.1.12.4.1.2.5604</ns2:HomeCommunityId>
      <ns2:RepositoryUniqueId>2.16.578.1.12.4.3.1.5.20.1</ns2:RepositoryUn
      iqueId>
      <ns2:DocumentUniqueId>2.16.578.1.12.4.3.1.1.20.2^105085430</ns2:Docu
      mentUniqueId>
      <ns2:mimeType>application/octet-stream</ns2:mimeType>
      <ns2:Document>
        <xop:Include xmlns:xop="http://www.w3.org/2004/08/xop/include" href="cid:b9a37cae-5d33-4ca1-9e3b-12997004d821-17@urn%3Aihe%3Aiti%3Aids-b%3A2007" />
      </ns2:Document>
    </ns2:DocumentResponse>
  </ns2:RetrieveDocumentSetResponse>
</soap:Body>
</soap:Envelope>

--uuid:84be98b6-2aec-415f-b691-a8e47f9f3b2d
Content-Type: application/octet-stream
Content-Transfer-Encoding: binary
Content-ID: <b9a37cae-5d33-4ca1-9e3b-12997004d821-17@urn:ihe:iti:xds-b:2007>

<ClinicalDocument classCode="DOCCLIN" moodCode="EVN" xmlns="urn:h17-org:v3"
xmlns:voc="urn:h17-org:v3/voc">
  <realmCode code="NO" />
  <typeId extension="POCD_HD000040" root="2.16.840.1.113883.1.3" />
  <templateId root="2.16.578.1.34.10.123" />
  <id extension="105085430" root="2.16.578.1.12.4.3.1.1.20.2" />
  <code code="B03-2" displayName="Poliklinisk notat" codeSystem="2.16.578.1.
  12.4.1.1.9602" />
  <title>Poliklinisk notat...</title>
  <effectiveTime value="20190402134909" />
  <confidentialityCode code="N" codeSystem="2.16.840.1.113883.5.25" />
  <languageCode code="no-NO" />
  <setId extension="105085430" root="2.16.578.1.12.4.3.1.1.20.2.15.1001" />
  <recordTarget typeCode="RCT" contextControlCode="OP">
    <patientRole classCode="PAT">
      <id extension="29019900248" root="2.16.578.1.12.4.1.4.1" />
      <patient classCode="PSN" determinerCode="INSTANCE">
        <name>
          <given>Karoline</given>
          <family>Testpasient Matre</family>
        </name>
        <administrativeGenderCode code="2" codeSystem="2.16.578.1.12.4.1.1.3
        101" displayName="Female" />
        <birthTime value="19990129" />
      </patient>
      <providerOrganization classCode="ORG" determinerCode="INSTANCE">
        <id extension="108604" root="2.16.578.1.12.4.1.4.102" />
        <name>Kirurgi Hamar</name>
        <asOrganizationPartOf>
          <wholeOrganization>
            <id extension="983971709" root="2.16.578.1.12.4.1.4.101" />
            <name>Sykehuset Innlandet HF</name>
          </wholeOrganization>
        </asOrganizationPartOf>

```

```

    </providerOrganization>
  </patientRole>
</recordTarget>
<author typeCode="AUT" contextControlCode="OP">
  <time value="20190402134930" />
  <assignedAuthor classCode="ASSIGNED">
    <id extension="UXOMGU" root="2.16.578.1.12.4.1.4.4" />
    <assignedPerson>
      <name>
        <given>Gunn</given>
        <family>Omsorg</family>
      </name>
    </assignedPerson>
  </assignedAuthor>
</author>
<custodian typeCode="CST">
  <assignedCustodian classCode="ASSIGNED">
    <representedCustodianOrganization classCode="ORG" determinerCode="INST
ANCE">
      <id extension="983971709" root="2.16.578.1.12.4.1.4.101" />
      <name>Sykehuset Innlandet HF</name>
    </representedCustodianOrganization>
  </assignedCustodian>
</custodian>
<component>
  <nonXMLBody>
    <text mediaType="application/pdf" representation="B64">JVBERi0xLjQNCiX
i48/TDQo1dDQold1BERiBieSBXUEN1YmVkieEdtYkggVjMuNTR4WzMyXQ0KJQ0KJQ0KMSAwIG9iaG0
8PC9UeXB1L01ldGFkYXRhL1N1YnR5cGUvWE1ML0xlbmd0aCAxMzc5ID4+DQpzdHJlYW0KPD94cGF
ja2V0IGJlZ2luPSLvu78iIGlkPSJXNU0wTXBDZWhpSHpyZVN6TlRjemtjOWQiPz4KPHg6eG1wbWV
0YSB4bWxuczp4PSJhZG9iZTpuczp4PSJhZG9iZTpuczp4PSJhZG9iZTpuczp4PSJhZG9iZTpuczp4
tbG5zOnJkZj0iaHR0cDovL3d3dy53My5vcmcvMTk5Oj8wMi8yMi1yZGYtc3ludGF4LW5zIyI+Cjx
yZGY6RGVzY3JpcHRpb24gcmRmOmFib3V0PSIiCiB4bWxuczp4bXA9Imh0dHA6Ly9ucy5hZG9iZS5
jb20veGFwLzEuMC8iPgogPHhtcDpDcmVhdG9yVG9vbC8+CiaA8eG1wOkNyZWFOZURhdGU+MjAxOS0
wNS0xMFQwOToyMj01N1o8L3htcDpDcmVhdGVEYXRlPgogPHhtcDpNb2RpZnleYXRlPjIwMTktMDU
tMTBUMDk6MjI6NTdaPC94bXA6TW9kaWZ5RGVzZG9yZG9yZG9yZG9yZG9yZG9yZG9yZG9yZG9yZG9y
tMTBUMDk6MjI6NTdaPC94bXA6TWV0YWRhdGFEYXRlPgo8L3JkZjpeZXNjcmlwdGlvbj4KPHJkZjpe
EZXNjcmlwdGlvbiByZGY6YWJvdXQ9IiIKIHhtbG5zOmRjPSJodHRwOi8vcHVybC5vcmcvZGMvZWx
lbWVudHMvMS4xLyI+CiaA8ZGM6Zm9ybWF0PmFwcGxpY2F0aW9uL3BkZjwvZGM6Zm9ybWF0PgogPGR
jOnRpdGx1PjxyZGY6QWw0PgogIDxyZGY6bGkgeG1sOmxhbm99IngtZGVmYXVsdCivPgo8L3JkZjpe
BbHQ+PC9kYzpw0aXRsZT4KIDxkYzpkZXNjcmlwdGlvbj48cmRmOkFsdD4KICA8cmRmOmxpIHhtbDp
sYW5nPSJ4LWRLZmF1bHQiLz4KPC9yZGY6QWw0PjwvZGM6ZGVzY3JpcHRpb24+CiaA8ZGM6c3ViamV
jdD4KIDxyZGY6QmFnPgogIDxyZGY6bGkvPgogPC9yZGY6QmFnPgo8L2RjOnN1YmplY3Q+CiaA8ZGM
6Y3JlYXRvcj48cmRmOlNlcT4KICA8cmRmOmxpIHhtbDpsYW5nPSJ4LWRLZmF1bHQiLz4KPC9yZGY
6U2VxPjwvZGM6Y3JlYXRvcj4KPC9yZGY6RGVzY3JpcHRpb24+CjxyZGY6RGVzY3JpcHRpb24gcmR
mOmFib3V0PSIiCiB4bWxuczp4YXBNTT0iaHR0cDovL25zLmFkb2JlLmNvbS94YXAvMS4wL21tLyI
+CiaA8eGFwTU06VmVyc2l1bklEPjE8L3hhcE1NOlZ1cnNpb25JRd4KIDx4YXBNTTpeb2N1bWVudEl
EPjliYzA1NDU1NjhlOTEzNGE4YzA1ZTI1M2I2NDBkYjBjPC94YXBNTTpeb2N1bWVudElEPgogPHh
hcE1NOKluc3RhbmN1SUQ+OWJjMDU0NTU0GU5MTM0YThjMDVlMjkyYjY0MGRiMGM8L3hhcE1NOKl
uc3RhbmN1SUQ+CjwvcmRmOkRlc2NyaXB0aW9uPgo8cmRmOkRlc2NyaXB0aW9uIHJkZjphYm91dD0
iIgoG1sbnM6GRmPSJodHRwOi8vb3N1bWVudG9yZG9yZG9yZG9yZG9yZG9yZG9yZG9yZG9yZG9yZG9y
yZHMvPgogPHBkZjpeQcm9kdWNlcj53UERGMyBieSBXUEN1YmVkieEdtYkg8L3BkZjpeQcm9kdWNlcj4
KPC9yZGY6RGVzY3JpcHRpb24+CjwvcmRmOlJERj4KPC94OnhtcG1ldGE+Cjw/eHBhY2tldCB1bmQ
9InciPz4KZW5kc3RyZWFtdDQplbmRvYmoKMIAWIG9iaG08PAOKL0NyZWFOb3IoKQovQXV0aG9yKCK
KL1RpdGx1KCKKL1N1YmplY3QoKQovS2V5d29yZHM0KQovQ3JlYXRpb25EYXRlKEQ6MjAxOTAMTA
wOTIyNTdaKQovTW9kRGF0ZShEOjIwMTktNTUwMDU0YThjMDVlMjkyYjY0MGRiMGM8L3hhcE1NOKl
QQ3ViZWQgR21iSCKncj4+IA1lbmRvYmoNCjQgMCMbYmoNPDwvTG9uZ3RoIDEwQovRmlsdGVyIFs
vRmxhdGVEZWNvZGVdID4+DQpzdHJlYW0KeJwrVCgEwkAgLFQw0DM0UjAAQjDwsRIITLXQT/Axkb

```

5.5 ITI-38 + ITI-40 request

```
<soap:Envelope xmlns:soap="http://www.w3.org/2003/05/soap-envelope">
  <soap:Header>
    <o:Security soap:mustUnderstand="true" xmlns:o="http://docs.oasis-open.org/wss/2004/01/oasis-200401-wss-wssecurity-secext-1.0.xsd" xmlns:s="http://www.w3.org/2003/05/soap-envelope">
      <u:Timestamp xmlns:u="http://docs.oasis-open.org/wss/2004/01/oasis-200401-wss-wssecurity-utility-1.0.xsd" u:Id="_0">
        <u:Created>2019-05-10T07:18:03.673Z</u:Created>
        <u:Expires>2019-05-10T07:23:03.673Z</u:Expires>
      </u:Timestamp>
      <saml:Assertion xmlns:saml="urn:oasis:names:tc:SAML:2.0:assertion" ID="_70bab571-5e1f-4588-8379-f40bd9e6de1c" IssueInstant="2019-05-10T07:18:02.955Z" Version="2.0">
        <saml:Issuer> sikkerhet.helsenorge.no</saml:Issuer>
        <Signature xmlns="http://www.w3.org/2000/09/xmldsig#">
          <SignedInfo>
            <CanonicalizationMethod Algorithm="http://www.w3.org/2001/10/xml-exc-c14n#" />
            <SignatureMethod Algorithm="http://www.w3.org/2001/04/xmldsig-more#rsa-sha256" />
            <Reference URI="#_70bab571-5e1f-4588-8379-f40bd9e6de1c">
              <Transforms>
                <Transform Algorithm="http://www.w3.org/2000/09/xmldsig#enveloped-signature" />
                <Transform Algorithm="http://www.w3.org/2001/10/xml-exc-c14n#" />
              </Transforms>
              <DigestMethod Algorithm="http://www.w3.org/2001/04/xmlenc#sha256" />
              <DigestValue>v7fkRZ17NIkThj9lg3oY/RILg7uCYLihiLq7JIjzLeo=</DigestValue>
            </Reference>
          </SignedInfo>
          <SignatureValue>f2Miy+/0MGa0UnsFEwXhWQKLYdMq2RwDp2DvmedKeI3sMifItgUhXIA11QaHHobJ03QS/aHxGk4TZRx4n9BiBUVgELoV6JBfF/FAoyVrRQnfMugQZrin56Y1XPT46LTH03JmOuEbwVZS2eD8Q/YPLVUzyGOFrSgz68XgrRqkgmre50ja0rIl/BvUeNfBDFR1/zAGcGCzZv7B0FR1kZx1jFKrT+P91Bp2wx9sy+9P/6z2dLt2YGcpKzRymvWNC31Tp/xLi+VLBTdpKCobqF2W8hE7NQmQPmo7TPFlc8dnOpAXATB9qFO05V/C9cUB4t/Td37o3mqiSMj3FoKAWiU5A==</SignatureValue>
          <KeyInfo>
            <X509Data>
              <X509Certificate>MIIFIzCCBAugAwIBAgILAU19LXLz+viLGWIwDQYJKoZIhvcNAQELBQAwUTELMAkGA1UEBhMCTk8xHTAbBgNVBAoMFEJleXBhc3MgQVMtOTgzMTYzMzI3MUMwIQQYDVQDDbPcdXlwYXNzIENsYXNzIDMgVGVzdDQgQ0EgMzAeFw0xNzA1MDgxMDUzMzdaFw0yMDA1MDgyMTU5MDBaMIGIMQswCQYDVQQGEwJOTzEhMB8GA1UECgwYRElSRUUtUT1JBVEVUUEZPUiBFLUhfTFFNFMRswGQYDVQQLEDBJozWxzZW5vcmdlLm5vIFRFU1QxJTAjBgNVBAMMHhHlbnlbn9yZ2Uubm8gU2lra2VyaGV0IFRFU1QxYjAQBgNVBAUTCTkxNTkzMzE0OTCCASIdQYJKoZIhvcNAQEBBQADggEPAPDCCAQoCggEBAO6CSeYwxt70nyfQ2XAPKFMoYU6F727IRrrBjpSgZa16k9opcPqfx1OVEDsrjoBw88G1vhtpu5hEa8mSlH0y/ccsnD7vhZ2q0TLPS51LzOXjfukt+0SpSV301alPAZ61+Qhgok6vi8LC
```

```

Xt0BBJIO3lahf6iTbwukMxwpcTzeKVhpLw9vU73yU++Mw2f91T6iW+62JP9NtSyaT7jJ5KpZkTGx
2QFTHEFUA/PX12To6X1C6HqoKjgXzePZJE4D69WbzwWXN93Nj713BTHA4ZRixISGDvL0NgSrbGXP
P3PK1IZS8oKB0716JQaxeSuesyDnFPZpTGnE4pl/CXFQ5gKlzkCAwEAAaOCACIwggG+MAkGA1UdE
wQCMAAwHwYDVR0jBBgwFoAUP671eAuSo3AgNV9a+vckoFIB8EEwHQYDVR0OBBYEFBehpcMyRVShJ
xmIahVgtwTdPGOGMA4GA1UdDwEB/wQEAWIGQDAWBgNVHSAEDzANMASGCWCEQgEaAQADAjCBuWYDV
R0fBIGzMIgwMDegNaAzhjFodHRwOi8vY3JsLnRlc3Q0LmJleXBhc3Mubm8vY3JsL0JQQ2xhc3MzV
DRDQTMuY3JsMHwg6Bxhm9sZGFwOi8vbGRhcC50ZXN0NC5idXlwYXNzLm5vL2RjPUJleXBhc3MsZ
GM9Tk8sQ049QnV5cGFzcyUyMENsYXNzJTJwMyUyMFRlc3Q0JTJwQ0ElMjAzP2NlcnRpZmljYXRlU
mV2b2NhdGlvbkxpc3QwgYoGCCsGAQUFBwEBBH4wFDA7BggrBgEFBQcwAYYvaHR0cDovL29jc3Aud
GVzdDQuYnV5cGFzcy5uby9vY3NwL0JQQ2xhc3MzVDRDQTMwPQYIKwYBBQUHMAKGMWh0dHA6Ly9jc
nQuDGVzdDQuYnV5cGFzcy5uby9jcnQvQlBDbGFzcnUNENBMy5jZXIwDQYJKoZIhvcNAQELBQADg
gEBAB14W1eqo4LN70unW7jr6YVPDDdTMaZv4A9e8V2B7YRLKkzWqKNhwj+B4dE//hlFi0uTbI877
BEC+WQqcXF7VNfC3XeK4ySQqnIaX9XxfkJa8NzMojlz4Jwyk0r/aUjw652p1Ao72OxvSIWjgJBaL
qMXnnLvTF2mhMBLarZ30MBpPcgRmcJgiZ5HslQnuGzmJK2/ByE9EC0AMczfdtHIVou3qylwa5tXH
GhBFiHyCCGZcwteN1RizSC80J319t7INVW/piXVWRKL7NuOL4CqUoM/JPhVYw1v9DGKJgAC3V7Gk
5sMqyjCThz1HZamOAJvjYhtveVz9DkppyGQDvAYsk=</X509Certificate>
  </X509Data>
  </KeyInfo>
  </Signature>
  <saml:Subject>
    <saml:NameID SPPprovidedID="29019900248">29019900248</saml:NameID>
    <saml:SubjectConfirmation Method="urn:oasis:names:tc:SAML:2.0:cm:b
earer" />
  </saml:Subject>
  <saml:Conditions NotBefore="2019-05-10T07:18:02.955Z" NotOnOrAfter="
2019-05-10T07:38:02.955Z">
    <saml:AudienceRestriction>
      <saml:Audience>https://xds-web.test.nhn.no/</saml:Audience>
    </saml:AudienceRestriction>
  </saml:Conditions>
  <saml:AttributeStatement>
    <saml:Attribute Name="urn:oasis:names:tc:xspa:1.0:subject:subject-
id">
      <saml:AttributeValue>Karoline Matre</saml:AttributeValue>
    </saml:Attribute>
    <saml:Attribute Name="urn:oasis:names:tc:xspa:1.0:subject:organiza
tion">
      <saml:AttributeValue>Norsk Helsenett</saml:AttributeValue>
    </saml:Attribute>
    <saml:Attribute Name="urn:oasis:names:tc:xspa:1.0:subject:organiza
tion-id">
      <saml:AttributeValue> <id xmlns="urn:hl7-org:v3" xsi:type="II" ex
tension="994598759" root="2.16.578.1.12.4.1.4.101" assigningAuthorityName="B
rønnøysundregistrene" displayable="false"/>
    </saml:AttributeValue>
  </saml:Attribute>
    <saml:Attribute Name="urn:ihe:iti:xca:2010:homeCommunityId">
      <saml:AttributeValue>urn:oid:2.16.578.1.12.4.1.7.1.2</saml:Attri
buteValue>
    </saml:Attribute>
    <saml:Attribute Name="urn:oasis:names:tc:xspa:2.0:subject:npi">
      <saml:AttributeValue>29019900248</saml:AttributeValue>
    </saml:Attribute>
    <saml:Attribute Name="urn:ihe:iti:xua:2017:subject:provider-identi
fier">
      <saml:AttributeValue><id xmlns="urn:hl7-org:v3" type="II" extens
ion="29019900248" root="2.16.578.1.12.4.1.4.1" displayable="false" />
    </saml:AttributeValue>
  </saml:AttributeStatement>

```

```

        </saml:Attribute>
        <saml:Attribute Name="urn:oasis:names:tc:xspa:1.0:subject:purposeo
fuse">
            <saml:AttributeValue><PurposeOfUse xmlns="urn:hl7-org:v3" type="
CE" code="13" codeSystem="1.0.14265.1" codeSystemName="ISO 14265 Classificat
ion of Purposes for processing personal health information" displayName="Sub
ject of care uses"/>
                </saml:AttributeValue>
            </saml:Attribute>
            <saml:Attribute Name="urn:oasis:names:tc:xacml:2.0:resource:resour
ce-id">
                <saml:AttributeValue>29019900248^^^&amp;2.16.578.1.12.4.1.4.
1&amp;ISO</saml:AttributeValue>
            </saml:Attribute>
            <saml:Attribute Name="SecurityLevel">
                <saml:AttributeValue>4</saml:AttributeValue>
            </saml:Attribute>
            <saml:Attribute Name="Scope">
                <saml:AttributeValue>innsynregisterbruk,innsynregisterinnhold,in
nsynspasientjournal</saml:AttributeValue>
            </saml:Attribute>
        </saml:AttributeStatement>
        <saml:AuthnStatement AuthnInstant="2019-05-10T07:18:02.955Z" Session
NotOnOrAfter="2019-05-10T07:38:02.955Z">
            <saml:AuthnContext>
                <saml:AuthnContextClassRef>urn:oasis:names:tc:SAML:2.0:ac:classe
s:X509</saml:AuthnContextClassRef>
            </saml:AuthnContext>
        </saml:AuthnStatement>
    </saml:Assertion>
</o:Security>
<Action soap:mustUnderstand="true" xmlns="http://www.w3.org/2005/08/addr
essing">urn:ihe:iti:2007:CrossGatewayQuery</Action>
<MessageID xmlns="http://www.w3.org/2005/08/addressing">urn:uuid:ce08026
9-ebb3-47c3-9733-85d29a718c30</MessageID>
<To xmlns="http://www.w3.org/2005/08/addressing">https://sds-apigwdz-61.
sykehuspartner.no/SP.Services.XCA/RespondingGatewayQuery.svc</To>
<ReplyTo soap:mustUnderstand="true" xmlns="http://www.w3.org/2005/08/add
ressing">
    <Address>http://www.w3.org/2005/08/addressing/anonymous</Address>
</ReplyTo>
</soap:Header>
<soap:Body>
    <ns4:AdhocQueryRequest xmlns:ns6="urn:oasis:names:tc:ebxml-regrep:xsd:lcm:3.0" xmlns:ns5="urn:ihe:iti:xds-b:2007" xmlns:ns4="urn:oasis:names:tc:ebxml-regrep:xsd:query:3.0" xmlns:ns3="urn:oasis:names:tc:ebxml-regrep:xsd:rs:3.0" xmlns:ns2="urn:oasis:names:tc:ebxml-regrep:xsd:rsm:3.0">
        <ns4:ResponseOption returnType="LeafClass" returnComposedObjects="true" />
        <ns2:AdhocQuery id="urn:uuid:14d4debf-8f97-4251-9a74-a90016b0af0d">
            <ns2:Slot name="$XDSDocumentEntryConfidentialityCode">
                <ns2:ValueList>
                    <ns2:Value>('L'^2.16.840.1.113883.5.25')</ns2:Value>
                    <ns2:Value>('M'^2.16.840.1.113883.5.25')</ns2:Value>
                    <ns2:Value>('N'^2.16.840.1.113883.5.25')</ns2:Value>
                    <ns2:Value>('U'^2.16.840.1.113883.5.25')</ns2:Value>
                    <ns2:Value>('R'^2.16.840.1.113883.5.25')</ns2:Value>
                </ns2:ValueList>
            </ns2:Slot>
        </ns2:AdhocQuery>
    </ns4:AdhocQueryRequest>
</soap:Body>
</soap:Envelope>
</pre>

```

```

        </ns2:Slot>
        <ns2:Slot name="$XDSDocumentEntryPatientId">
          <ns2:ValueList>
            <ns2:Value>'29019900248^^^&amp;2.16.578.1.12.4.1.4.1&amp;ISO'</n
ns2:Value>
          </ns2:ValueList>
        </ns2:Slot>
        <ns2:Slot name="$XDSDocumentEntryStatus">
          <ns2:ValueList>
            <ns2:Value>('urn:oasis:names:tc:ebxml-regrep:StatusType:Approved
')</ns2:Value>
          </ns2:ValueList>
        </ns2:Slot>
      </ns2:AdhocQuery>
    </ns4:AdhocQueryRequest>
  </soap:Body>
</soap:Envelope>

```

5.6 ITI-38 response

Note: The Security header is in the example included with mustUnderstand="0" (false). The Security header can also be fully omitted in the response.

```

<s:Envelope xmlns:s="http://www.w3.org/2003/05/soap-envelope" xmlns:a="http://ww
w.w3.org/2005/08/addressing" xmlns:u="http://docs.oasis-open.org/wss/2004/01/oas
is-200401-wss-wssecurity-utility-1.0.xsd">
  <s:Header>
    <a:Action s:mustUnderstand="1">urn:ihe:iti:2007:CrossGatewayQueryResponse</a
:Action>
    <ActivityId CorrelationId="090322c2-4c71-42ff-84bd-fed1c2986a0c" xmlns="http
://schemas.microsoft.com/2004/09/ServiceModel/Diagnostics">00000000-0000-0000-00
00-000000000000</ActivityId>
    <a:RelatesTo>urn:uuid:ce080269-ebb3-47c3-9733-85d29a718c30</a:RelatesTo>
    <a:MessageID>urn:uuid:63c8cf6e-09eb-4f81-ae21-61f8cb392643</a:MessageID>
    <o:Security s:mustUnderstand="0" xmlns:o="http://docs.oasis-open.org/wss/200
4/01/oasis-200401-wss-wssecurity-secext-1.0.xsd">
      <u:Timestamp u:Id="_0">
        <u:Created>2019-05-10T07:18:04.383Z</u:Created>
        <u:Expires>2019-05-10T07:23:04.383Z</u:Expires>
      </u:Timestamp>
    </o:Security>
  </s:Header>
  <s:Body xmlns:xsi="http://www.w3.org/2001/XMLSchema-instance" xmlns:xsd="http:
//www.w3.org/2001/XMLSchema">
    <AdhocQueryResponse status="urn:oasis:names:tc:ebxml-regrep:ResponseStatusTy
pe:Success" totalResultCount="15" xmlns="urn:oasis:names:tc:ebxml-regrep:xsd:que
ry:3.0">
      <RegistryObjectList xmlns="urn:oasis:names:tc:ebxml-regrep:xsd:rim:3.0">
        <ExtrinsicObject id="urn:uuid:03df3d45-0000-0000-0000-000000000000" home
="2.16.578.1.12.4.1.2.5604" objectType="urn:uuid:7edca82f-054d-47f2-a032-9b2a5b5
186c1" status="urn:oasis:names:tc:ebxml-regrep:StatusType:Approved" mimeType="te
xt/rtf">
          <Slot name="repositoryUniqueId">
            <ValueList>

```

```

        <Value>2.16.578.1.12.4.3.1.4.20.1</Value>
    </ValueList>
</Slot>
<Slot name="creationTime">
    <ValueList>
        <Value>20171126174700</Value>
    </ValueList>
</Slot>
<Slot name="languageCode">
    <ValueList>
        <Value>no</Value>
    </ValueList>
</Slot>
<Slot name="legalAuthenticator">
    <ValueList>
        <Value>RILIN^Lin^Rita^^^^^^&2.16.578.1.12.4.1.4.4&ISO</Val
ue>
    </ValueList>
</Slot>
<Slot name="size">
    <ValueList>
        <Value>0</Value>
    </ValueList>
</Slot>
<Slot name="hash">
    <ValueList>
        <Value>da39a3ee5e6b4b0d3255bfef95601890afd80709</Value>
    </ValueList>
</Slot>
<Slot name="sourcePatientId">
    <ValueList>
        <Value>29019900248^^^&2.16.578.1.12.4.1.4.1&ISO</Value>
    </ValueList>
</Slot>
<Slot name="sourcePatientInfo">
    <ValueList>
        <Value>PID-2|^2110534</Value>
        <Value>PID-5|Matre^Karoline Testpasient^^^</Value>
        <Value>PID-7|19990129</Value>
        <Value>PID-8|F</Value>
    </ValueList>
</Slot>
<Name>
    <LocalizedString value="Epikrise - mor" />
</Name>
<Classification objectType="urn:oasis:names:tc:ebxmlregrep:ObjectType:
RegistryObject:Classification" classificationScheme="urn:uuid:93606bcf-9494-43ec
-9b4e-a7748d1a838d" classifiedObject="urn:uuid:03df3d45-0000-0000-0000-000000000
000" nodeRepresentation="author">
    <Slot name="authorPerson">
        <ValueList>
            <Value>RILIN^Lin^Rita^^^^^^&2.16.578.1.12.4.1.4.4&ISO</V
alue>
        </ValueList>
    </Slot>
    <Slot name="authorInstitution">
        <ValueList>

```



```

        <Value>Kvinneklinikken^^^^^&2.16.578.1.12.4.1.4.102&ISO^
^^^108048</Value>
        <Value>Sykehuset Østfold HF (PK2b 02.10.2018)^^^^^^^^^</Value>
        <Value>Sykehuset Østfold HF^^^^^&2.16.578.1.12.4.1.4.101&
;ISO^^^^983971768</Value>
    </ValueList>
</Slot>
<Slot name="authorRole">
    <ValueList>
        <Value>Partus-forvalter</Value>
    </ValueList>
</Slot>
</Classification>
<Classification id="urn:uuid:284d790c-4f48-4e54-bf52-60ac527d90b1" obj
ectType="urn:oasis:names:tc:ebxml-regrep:ObjectType:RegistryObject:Classificatio
n" classificationScheme="urn:uuid:f33fb8ac-18af-42cc-ae0e-ed0b0bdb91e1" classifi
edObject="urn:uuid:03df3d45-0000-0000-0000-000000000000" nodeRepresentation="86.
101">
    <Slot name="codingScheme">
        <ValueList>
            <Value>2.16.578.1.12.4.1.1.1303</Value>
        </ValueList>
    </Slot>
    <Name>
        <LocalizedString value="Alminnelige somatiske sykehus" />
    </Name>
</Classification>
<Classification id="urn:uuid:7d2a440b-8bb9-44d5-bf15-444276861f0b" obj
ectType="urn:oasis:names:tc:ebxmlregrep:ObjectType:RegistryObject:Classification
" classificationScheme="urn:uuid:41a5887f-8865-4c09-adf7-e362475b143a" classifie
dObject="urn:uuid:03df3d45-0000-0000-0000-000000000000" nodeRepresentation="A00-
1">
    <Slot name="codingScheme">
        <ValueList>
            <Value>2.16.578.1.12.4.1.1.9602</Value>
        </ValueList>
    </Slot>
    <Name>
        <LocalizedString value="Epikriser og sammenfatninger" />
    </Name>
</Classification>
<Classification objectType="urn:oasis:names:tc:ebxmlregrep:ObjectType:
RegistryObject:Classification" classificationScheme="urn:uuid:f4f85eac-e6cb-4883
-b524-f2705394840f" classifiedObject="urn:uuid:03df3d45-0000-0000-0000-0000000000
000" nodeRepresentation="N">
    <Slot name="codingScheme">
        <ValueList>
            <Value>2.16.840.1.113883.5.25</Value>
        </ValueList>
    </Slot>
    <Name>
        <LocalizedString value="normal" />
    </Name>
</Classification>
<Classification objectType="urn:oasis:names:tc:ebxml-regrep:ObjectType
:RegistryObject:Classification" classificationScheme="urn:uuid:a09d5840-386c-46f
2-b5ad-9c3699a4309d" classifiedObject="urn:uuid:03df3d45-0000-0000-0000-00000000
0000" nodeRepresentation="urn:no:ehelse:document:text">

```

```

        <Slot name="codingScheme">
            <ValueList>
                <Value>FormatCodes</Value>
            </ValueList>
        </Slot>
        <Name>
            <LocalizedString value="urn:no:ehelse:document:text" />
        </Name>
    </Classification>
    <Classification id="urn:uuid:97198c72-96d6-4765-888d-526c4fbcf639" obj
ectType="urn:oasis:names:tc:ebxmlregrep:ObjectType:RegistryObject:Classification
" classificationScheme="urn:uuid:ccc5598-8b07-4b77-a05e-ae952c785ead" classifie
dObject="urn:uuid:03df3d45-0000-0000-0000-000000000000" nodeRepresentation="Ukje
nt">
        <Slot name="codingScheme">
            <ValueList>
                <Value>Ukjent</Value>
            </ValueList>
        </Slot>
        <Name>
            <LocalizedString value="Ukjent" />
        </Name>
    </Classification>
    <Classification objectType="urn:oasis:names:tc:ebxmlregrep:ObjectType:
RegistryObject:Classification" classificationScheme="urn:uuid:f0306f51-975f-434e
-a61c-c59651d33983" classifiedObject="urn:uuid:03df3d45-0000-0000-0000-000000000
000" nodeRepresentation="A03-2">
        <Slot name="codingScheme">
            <ValueList>
                <Value>2.16.578.1.12.4.1.1.9602</Value>
            </ValueList>
        </Slot>
        <Name>
            <LocalizedString value="Epikrise" />
        </Name>
    </Classification>
    <ExternalIdentifier id="urn:uuid:fb7cf1cb-b6cc-42e7-bf87-f4ee2f598b84"
objectType="urn:oasis:names:tc:ebxml-regrep:ObjectType:RegistryObject:ExternalId
entifier" registryObject="urn:uuid:03df3d45-0000-0000-0000-000000000000" identif
icationScheme="urn:uuid:58a6f841-87b3-4a3e-92fd-a8ffeff98427" value="29019900248
^^^&2.16.578.1.12.4.1.4.1&ISO">
        <Name>
            <LocalizedString value="XSDDocumentEntry.patientId" />
        </Name>
    </ExternalIdentifier>
    <ExternalIdentifier id="urn:uuid:bf3a6a68-5f8d-49b8-ae8c-100f307161f1"
objectType="urn:oasis:names:tc:ebxml-regrep:ObjectType:RegistryObject:ExternalId
entifier" registryObject="urn:uuid:03df3d45-0000-0000-0000-000000000000" identif
icationScheme="urn:uuid:2e82c1f6-a085-4c72-9da3-8640a32e42ab" value="^64961861">
        <Name>
            <LocalizedString value="XSDDocumentEntry.uniqueId" />
        </Name>
    </ExternalIdentifier>
</ExtrinsicObject>
<ExtrinsicObject id="urn:uuid:03df3d1b-0000-0000-0000-000000000000" home
="2.16.578.1.12.4.1.2.5604" objectType="urn:uuid:7edca82f-054d-47f2-a032-9b2a5b5
186c1" status="urn:oasis:names:tc:ebxml-regrep:StatusType:Approved" mimeType="te
xt/rtf">

```

```

<Slot name="repositoryUniqueId">
  <ValueList>
    <Value>2.16.578.1.12.4.3.1.4.20.1</Value>
  </ValueList>
</Slot>
<Slot name="creationTime">
  <ValueList>
    <Value>20171126174800</Value>
  </ValueList>
</Slot>
<Slot name="languageCode">
  <ValueList>
    <Value>no</Value>
  </ValueList>
</Slot>
<Slot name="legalAuthenticator">
  <ValueList>
    <Value>RILIN^Lin^Rita^^^^^^&2.16.578.1.12.4.1.4.4&ISO</Val
ue>
  </ValueList>
</Slot>
<Slot name="size">
  <ValueList>
    <Value>0</Value>
  </ValueList>
</Slot>
<Slot name="hash">
  <ValueList>
    <Value>da39a3ee5e6b4b0d3255bfe95601890afd80709</Value>
  </ValueList>
</Slot>
<Slot name="sourcePatientId">
  <ValueList>
    <Value>29019900248^^^&2.16.578.1.12.4.1.4.1&ISO</Value>
  </ValueList>
</Slot>
<Slot name="sourcePatientInfo">
  <ValueList>
    <Value>PID-2|^2110534</Value>
    <Value>PID-5|Matre^Karoline Testpasient^^^</Value>
    <Value>PID-7|19990129</Value>
    <Value>PID-8|F</Value>
  </ValueList>
</Slot>
<Name>
  <LocalizedString value="IKKE SIGNERT Epikrise - mor" />
</Name>
<Classification objectType="urn:oasis:names:tc:ebxmlregrep:ObjectType:
RegistryObject:Classification" classificationScheme="urn:uuid:93606bcf-9494-43ec
-9b4e-a7748d1a838d" classifiedObject="urn:uuid:03df3d1b-0000-0000-0000-0000000000
00" nodeRepresentation="author">
  <Slot name="authorPerson">
    <ValueList>
      <Value>RILIN^Lin^Rita^^^^^^&2.16.578.1.12.4.1.4.4&ISO</V
alue>
    </ValueList>
  </Slot>
  <Slot name="authorInstitution">

```

```

    <ValueList>
      <Value>Kvinneklinikken^^^^^&2.16.578.1.12.4.1.4.102&ISO^
^^^^108048</Value>
      <Value>Sykehuset Østfold HF (PK2b 02.10.2018)^^^^^^^^^</Value>
      <Value>Sykehuset Østfold HF^^^^^&2.16.578.1.12.4.1.4.101&
;ISO^^^^983971768</Value>
    </ValueList>
  </Slot>
  <Slot name="authorRole">
    <ValueList>
      <Value>Partus-forvalter</Value>
    </ValueList>
  </Slot>
</Classification>
<Classification id="urn:uuid:3c548e64-bc5b-42df-937f-d795df8eb557" obj
ectType="urn:oasis:names:tc:ebxml-regrep:ObjectType:RegistryObject:Classificatio
n" classificationScheme="urn:uuid:f33fb8ac-18af-42cc-ae0e-ed0b0bdb91e1" classifi
edObject="urn:uuid:03df3d1b-0000-0000-0000-000000000000" nodeRepresentation="86.
101">
  <Slot name="codingScheme">
    <ValueList>
      <Value>2.16.578.1.12.4.1.1.1303</Value>
    </ValueList>
  </Slot>
  <Name>
    <LocalizedString value="Alminnelige somatiske sykehus" />
  </Name>
</Classification>
<Classification id="urn:uuid:c11d6683-25b0-4164-bbf6-4a32efb1de26" obj
ectType="urn:oasis:names:tc:ebxmlregrep:ObjectType:RegistryObject:Classification
" classificationScheme="urn:uuid:41a5887f-8865-4c09-adf7-e362475b143a" classifie
dObject="urn:uuid:03df3d1b-0000-0000-0000-000000000000" nodeRepresentation="A00-
1">
  <Slot name="codingScheme">
    <ValueList>
      <Value>2.16.578.1.12.4.1.1.9602</Value>
    </ValueList>
  </Slot>
  <Name>
    <LocalizedString value="Epikriser og sammenfatninger" />
  </Name>
</Classification>
<Classification objectType="urn:oasis:names:tc:ebxmlregrep:ObjectType:
RegistryObject:Classification" classificationScheme="urn:uuid:f4f85eac-e6cb-4883
-b524-f2705394840f" classifiedObject="urn:uuid:03df3d1b-0000-0000-0000-000000000
000" nodeRepresentation="N">
  <Slot name="codingScheme">
    <ValueList>
      <Value>2.16.840.1.113883.5.25</Value>
    </ValueList>
  </Slot>
  <Name>
    <LocalizedString value="normal" />
  </Name>
</Classification>
<Classification objectType="urn:oasis:names:tc:ebxml-regrep:ObjectType
:RegistryObject:Classification" classificationScheme="urn:uuid:a09d5840-386c-46f

```

```

2-b5ad-9c3699a4309d" classifiedObject="urn:uuid:03df3d1b-0000-0000-0000-00000000
0000" nodeRepresentation="urn:no:ehelse:document:text">
  <Slot name="codingScheme">
    <ValueList>
      <Value>FormatCodes</Value>
    </ValueList>
  </Slot>
  <Name>
    <LocalizedString value="urn:no:ehelse:document:text" />
  </Name>
</Classification>
<Classification id="urn:uuid:c546c88d-7fbf-499e-ad14-cc5f2c1ec938" obj
ectType="urn:oasis:names:tc:ebxmlregrep:ObjectType:RegistryObject:Classification
" classificationScheme="urn:uuid:ccc5598-8b07-4b77-a05e-ae952c785ead" classifie
dObject="urn:uuid:03df3d1b-0000-0000-0000-000000000000" nodeRepresentation="Ukje
nt">
  <Slot name="codingScheme">
    <ValueList>
      <Value>Ukjent</Value>
    </ValueList>
  </Slot>
  <Name>
    <LocalizedString value="Ukjent" />
  </Name>
</Classification>
<Classification objectType="urn:oasis:names:tc:ebxmlregrep:ObjectType:
RegistryObject:Classification" classificationScheme="urn:uuid:f0306f51-975f-434e
-a61c-c59651d33983" classifiedObject="urn:uuid:03df3d1b-0000-0000-0000-0000000000
00" nodeRepresentation="A03-2">
  <Slot name="codingScheme">
    <ValueList>
      <Value>2.16.578.1.12.4.1.1.9602</Value>
    </ValueList>
  </Slot>
  <Name>
    <LocalizedString value="Epikrise" />
  </Name>
</Classification>
<ExternalIdentifier id="urn:uuid:c96cb921-b7cf-4e35-ad98-320909c1e605"
objectType="urn:oasis:names:tc:ebxml-regrep:ObjectType:RegistryObject:ExternalId
entifier" registryObject="urn:uuid:03df3d1b-0000-0000-0000-000000000000" identif
icationScheme="urn:uuid:58a6f841-87b3-4a3e-92fd-a8ffeff98427" value="29019900248
^^^&2.16.578.1.12.4.1.4.1&ISO">
  <Name>
    <LocalizedString value="XSDDocumentEntry.patientId" />
  </Name>
</ExternalIdentifier>
<ExternalIdentifier id="urn:uuid:cadf27a4-561c-4913-a5e7-81616ab46234"
objectType="urn:oasis:names:tc:ebxml-regrep:ObjectType:RegistryObject:ExternalId
entifier" registryObject="urn:uuid:03df3d1b-0000-0000-0000-000000000000" identif
icationScheme="urn:uuid:2e82c1f6-a085-4c72-9da3-8640a32e42ab" value="^64961819">
  <Name>
    <LocalizedString value="XSDDocumentEntry.uniqueId" />
  </Name>
</ExternalIdentifier>
</ExtrinsicObject>
<ExtrinsicObject id="urn:uuid:06437a49-0000-0000-0000-000000000000" home
="2.16.578.1.12.4.1.2.5604" objectType="urn:uuid:7edca82f-054d-47f2-a032-9b2a5b5

```

```

186c1" status="urn:oasis:names:tc:ebxml-regrep:StatusType:Approved" mimeType="text/rtf">
  <Slot name="repositoryUniqueId">
    <ValueList>
      <Value>2.16.578.1.12.4.3.1.5.20.1</Value>
    </ValueList>
  </Slot>
  <Slot name="creationTime">
    <ValueList>
      <Value>20180305114733</Value>
    </ValueList>
  </Slot>
  <Slot name="languageCode">
    <ValueList>
      <Value>no</Value>
    </ValueList>
  </Slot>
  <Slot name="legalAuthenticator">
    <ValueList>
      <Value>9144889^Koman^Magnar^^^^^^&2.16.578.1.12.4.1.4.4&ISO</Value>
    </ValueList>
  </Slot>
  <Slot name="size">
    <ValueList>
      <Value>0</Value>
    </ValueList>
  </Slot>
  <Slot name="hash">
    <ValueList>
      <Value>da39a3ee5e6b4b0d3255bfe95601890afd80709</Value>
    </ValueList>
  </Slot>
  <Slot name="sourcePatientId">
    <ValueList>
      <Value>29019900248^^^&2.16.578.1.12.4.1.4.1&ISO</Value>
    </ValueList>
  </Slot>
  <Slot name="sourcePatientInfo">
    <ValueList>
      <Value>PID-2|^7038181</Value>
      <Value>PID-5|Testpasient Matre^Karoline^^^</Value>
      <Value>PID-7|19990129</Value>
      <Value>PID-8|F</Value>
    </ValueList>
  </Slot>
  <Name>
    <LocalizedString value="Poliklinisk notat Telefon" />
  </Name>
  <Classification objectType="urn:oasis:names:tc:ebxmlregrep:ObjectType:RegistryObject:Classification" classificationScheme="urn:uuid:93606bcf-9494-43ec-9b4e-a7748d1a838d" classifiedObject="urn:uuid:06437a49-0000-0000-0000-000000000000" nodeRepresentation="author">
    <Slot name="authorPerson">
      <ValueList>
        <Value>9144889^Koman^Magnar^^^^^^&2.16.578.1.12.4.1.4.4&ISO</Value>
      </ValueList>
    </Slot>
  </Classification>

```

```

        </Slot>
        <Slot name="authorInstitution">
            <ValueList>
                <Value>Kirurgi Hamar^^^^^&amp;2.16.578.1.12.4.1.4.102&amp;ISO^^^
^108604</Value>
                <Value>^^^^^^^^^^</Value>
                <Value>Sykehuset Innlandet HF^^^^^&amp;2.16.578.1.12.4.1.4.101&a
mp;ISO^^^^983971709</Value>
            </ValueList>
        </Slot>
        <Slot name="authorRole">
            <ValueList>
                <Value>Rekvirent</Value>
            </ValueList>
        </Slot>
    </Classification>
    <Classification id="urn:uuid:8422104b-66ad-4057-a8a1-6bf4c2a968d2" obj
ectType="urn:oasis:names:tc:ebxml-regrep:ObjectType:RegistryObject:Classificatio
n" classificationScheme="urn:uuid:f33fb8ac-18af-42cc-ae0e-ed0b0bdb91e1" classifi
edObject="urn:uuid:06437a49-0000-0000-0000-000000000000" nodeRepresentation="86.
101">
        <Slot name="codingScheme">
            <ValueList>
                <Value>2.16.578.1.12.4.1.1.1303</Value>
            </ValueList>
        </Slot>
        <Name>
            <LocalizedString value="Alminnelige somatiske sykehus" />
        </Name>
    </Classification>
    <Classification id="urn:uuid:a4d733b4-6ele-4be6-a624-a5bf212168e2" obj
ectType="urn:oasis:names:tc:ebxmlregrep:ObjectType:RegistryObject:Classification
" classificationScheme="urn:uuid:41a5887f-8865-4c09-adf7-e362475b143a" classifie
dObject="urn:uuid:06437a49-0000-0000-0000-000000000000" nodeRepresentation="B00-
1">
        <Slot name="codingScheme">
            <ValueList>
                <Value>2.16.578.1.12.4.1.1.19602</Value>
            </ValueList>
        </Slot>
        <Name>
            <LocalizedString value="Kontinuerlig/løpende journal" />
        </Name>
    </Classification>
    <Classification objectType="urn:oasis:names:tc:ebxmlregrep:ObjectType:
RegistryObject:Classification" classificationScheme="urn:uuid:f4f85eac-e6cb-4883
-b524-f2705394840f" classifiedObject="urn:uuid:06437a49-0000-0000-0000-000000000
000" nodeRepresentation="N">
        <Slot name="codingScheme">
            <ValueList>
                <Value>2.16.840.1.113883.5.25</Value>
            </ValueList>
        </Slot>
        <Name>
            <LocalizedString value="normal" />
        </Name>
    </Classification>

```

```

    <Classification objectType="urn:oasis:names:tc:ebxml-regrep:ObjectType:RegistryObject:Classification" classificationScheme="urn:uuid:a09d5840-386c-46f2-b5ad-9c3699a4309d" classifiedObject="urn:uuid:06437a49-0000-0000-0000-00000000" nodeRepresentation="urn:no:ehelse:document:text">
      <Slot name="codingScheme">
        <ValueList>
          <Value>FormatCodes</Value>
        </ValueList>
      </Slot>
      <Name>
        <LocalizedString value="urn:no:ehelse:document:text" />
      </Name>
    </Classification>
    <Classification id="urn:uuid:99f16981-72be-4c25-b03d-0e05b1c6a96b" objectType="urn:oasis:names:tc:ebxmlregrep:ObjectType:RegistryObject:Classification" classificationScheme="urn:uuid:cccf5598-8b07-4b77-a05e-ae952c785ead" classifiedObject="urn:uuid:06437a49-0000-0000-0000-000000000000" nodeRepresentation="Ukjent">
      <Slot name="codingScheme">
        <ValueList>
          <Value>Ukjent</Value>
        </ValueList>
      </Slot>
      <Name>
        <LocalizedString value="Ukjent" />
      </Name>
    </Classification>
    <Classification objectType="urn:oasis:names:tc:ebxmlregrep:ObjectType:RegistryObject:Classification" classificationScheme="urn:uuid:f0306f51-975f-434e-a61c-c59651d33983" classifiedObject="urn:uuid:06437a49-0000-0000-0000-0000000000" nodeRepresentation="B03-2">
      <Slot name="codingScheme">
        <ValueList>
          <Value>2.16.578.1.12.4.1.1.9602</Value>
        </ValueList>
      </Slot>
      <Name>
        <LocalizedString value="Poliklinisk notat" />
      </Name>
    </Classification>
    <ExternalIdentifier id="urn:uuid:7a550acd-8534-4f3f-839a-21aed3d63efd" objectType="urn:oasis:names:tc:ebxml-regrep:ObjectType:RegistryObject:ExternalIdentifier" registryObject="urn:uuid:06437a49-0000-0000-0000-000000000000" identificationScheme="urn:uuid:58a6f841-87b3-4a3e-92fd-a8ffeff98427" value="29019900248^^^&2.16.578.1.12.4.1.4.1&ISO">
      <Name>
        <LocalizedString value="XSDDocumentEntry.patientId" />
      </Name>
    </ExternalIdentifier>
    <ExternalIdentifier id="urn:uuid:27c46e61-e21c-4406-a553-d02b1f34945d" objectType="urn:oasis:names:tc:ebxml-regrep:ObjectType:RegistryObject:ExternalIdentifier" registryObject="urn:uuid:06437a49-0000-0000-0000-000000000000" identificationScheme="urn:uuid:2e82c1f6-a085-4c72-9da3-8640a32e42ab" value="105085513">
      <Name>
        <LocalizedString value="XSDDocumentEntry.uniqueId" />
      </Name>
    </ExternalIdentifier>

```



```
</ExtrinsicObject>
</RegistryObjectList>
</AdhocQueryResponse>
</s:Body>
</s:Envelope>
```

5.7 ITI-39 + ITI-40 request

```
<soap:Envelope xmlns:soap="http://www.w3.org/2003/05/soap-envelope">
  <soap:Header>
    <o:Security soap:mustUnderstand="true" xmlns:o="http://docs.oasis-open.org/wss/2004/01/oasis-200401-wss-wssecurity-secext-1.0.xsd" xmlns:s="http://www.w3.org/2003/05/soap-envelope">
      <u:Timestamp xmlns:u="http://docs.oasis-open.org/wss/2004/01/oasis-200401-wss-wssecurity-utility-1.0.xsd" u:Id="_0">
        <u:Created>2019-05-10T07:22:56.765Z</u:Created>
        <u:Expires>2019-05-10T07:27:56.765Z</u:Expires>
      </u:Timestamp>
      <saml:Assertion xmlns:saml="urn:oasis:names:tc:SAML:2.0:assertion" ID="_d72f1016-7438-4754-ba93-e9cad659819c" IssueInstant="2019-05-10T07:22:56.533Z" Version="2.0">
        <saml:Issuer>ikkerhet.helsenorge.no</saml:Issuer>
        <Signature xmlns="http://www.w3.org/2000/09/xmldsig#">
          <SignedInfo>
            <CanonicalizationMethod Algorithm="http://www.w3.org/2001/10/xml-exc-c14n#" />
            <SignatureMethod Algorithm="http://www.w3.org/2001/04/xmldsig-more#rsa-sha256" />
            <Reference URI="#_d72f1016-7438-4754-ba93-e9cad659819c">
              <Transforms>
                <Transform Algorithm="http://www.w3.org/2000/09/xmldsig#envelopesignature" />
                <Transform Algorithm="http://www.w3.org/2001/10/xml-exc-c14n#" />
              </Transforms>
              <DigestMethod Algorithm="http://www.w3.org/2001/04/xmlenc#sha256" />
              <DigestValue>Kj7/8RM1IspD8CDuC5R2du/Cm8zWOVDtgav9v+VhURs=</DigestValue>
            </Reference>
          </SignedInfo>
          <SignatureValue>vyKykJtLITxsnXWpgcVfJd78WzQG7oll8LmpyZGoNyL+L43wJowoJL54BBzDpZMewDVXzumTVxjBiJe1EC7+xQQzQkgt1J2MiDxFbIXOMkT3Q+Hv+NXlPZ4Dr0Wbt5DP5TsKn4os98zpTL5vkyf+xjtQekKjJbbIu4n3zQLITCpPcG2Ippqu07n89mUvC8Xp8yH85vdr3rILzkqHtgYzSvMICvqGGt6+npzPDKFn2pJtRUgq7zLLaidT+thgJaDQyjtHk03dw/Jkkjz9X3CBkDyPohgqw1pv6EwRLYAmkypAJYJWRLPKHsUhrXfBLbmL9v3zFtF2nD5+WWwE9pGXA==</SignatureValue>
          <KeyInfo>
            <X509Data>
              <X509Certificate>MIIIFIzCCBAugAwIBAgILAUl9LXLZ+viLGIWdQYJKoZIhvcNAQELBQAwUTELMAkGA1UEBhMCTk8xHTAbBgNVBAAoMFEJleXBhc3MgQVMtOTgzMTYzMzI3MSMwIQYDVQQDDGpCdXlwYXNzIENsYXNzIDMgVGZkdDQgQ0EgMzAeFw0xNzA1MDgxMDUzMDZlZjMwYMDA1MDgyMTU5MDBaMIGIMQswCQYDVQQGEwJOTzEhMB8GA1UECgwYRE1SRUtUT1JBVEVUeUZPUEiBFUhhFjTfNFMRswGQYDVQQQLD BJozWxzZU5vcmdlM1M5vIFRFU1QxJTAjBgNVBAMHEhlibHBlbm9yZ2Uubm8gU21ra2VyaGV0IFRFU1QxZjAQBgNVBAUTCTkxNTkzMzE0OTCCASIdQYJKoZIhvcNAQEABBQADggEPADCCAQoCggEBAO6CSeYWxwt70
```

```

nyfQ2XAPKFMoYU6F727IRrrBjpsGZa16k9opcPqfx1OVEDsrjoBw88G1vhtpu5hEa8mSlH0y/ccsnD7v
hZ2q0TLPS51LzOXjfukt+0SpSV301alPAZ61+Qhgok6vi8LCXt0BBJIO3lahf6iTbwukMxwpcTzeKVhp
Lw9vU73yU++Mw2f91T6iW+62JP9NtSyaT7jJ5KpZkTGx2QFTHEFUA/PX12To6X1C6HqoKjgXzePZJE4D
69WbzwWXN93Nj713BTHA4ZRixISGDvL0NgSrbGXPP3PK1IZS8oKB0716JQaxeSuesyDnFPZpTGnE4p1/
CXFQ5gKlzkCAwEAAaOCacIwggG+MAkGA1UdEwQCAAwHwYDVR0jBBgwFoAUP671eAuSo3AgNV9a+vcko
FIB8EEwHQYDVR0OBBYEFBehpcMyRVShJxmIahVgtwTdPGOGMA4GA1UdDwEB/wQEAWIGQDAWBgNVHSAED
zANMAsGCWCEQgEaAQADAjCBuwYDVR0fBIGzMIGwMDEgNaAzhjFodHRwOi8vY3JsLnRlc3Q0LmJleXBhc
3Mubm8vY3JsL0JQQ2xhc3MzVDRDQTMuY3JsMHWgc6Bxhm9sZGFwOi8vbGRhcC50ZXN0NC5idXlwYXNzL
m5vL2RjPUJleXBhc3MsZGM9Tk8sQ049QnV5cGFzcyUyMENsYXNzJTlWMyUyMFRlc3Q0JTlWQ0ElMjAzP
2NlcnRpZmljYXRlUmV2b2NhdGlvbkxpc3QwgYoGCCsGAQUFBwEBB4wFDA7BggrBgEFBQcwAYYvaHR0c
DovL29jc3AudGVzdDQuYnV5cGFzcy5uby9vY3NwL0JQQ2xhc3MzVDRDQTMwPQYIKwYBBQUHMAKGMWh0d
HA6Ly9jcnQudGVzdDQuYnV5cGFzcy5uby9jcnQvQlBDbGFzcnUNENBM5jZXIwDQYJKoZIhvcNAQELB
QADggEBAB14W1eqo4LN70unW7jr6YVPDDdTMaZv4A9e8V2B7YRLKKzWqKNhwj+B4dE//hlFi0uTbI877
BEC+WQqcXF7Vnfc3XeK4ySQqnIaX9XxfkJa8NzMojlz4Jwyk0r/aUjw652p1Ao72OxvSIWjgJBaLqMXn
nLvTF2mhMBLarZ30MBPcgrmcJgiZ5HslQnuGzmJK2/ByE9EC0AMczfdtHIVou3qylwa5tXHGHBFiHyC
CGZcwteN1RizSC80J319t7INVW/piXVWRKL7NuOL4CqUoM/JPhVYwlv9DGKJgAC3V7Gk5sMqyjCThzlh
ZamOAJvjYhtveVz9DkppyGQDvAYskc=</X509Certificate>
  </X509Data>
</KeyInfo>
</Signature>
<saml:Subject>
  <saml:NameID SPProvidedID="29019900248">29019900248</saml:NameID>
  <saml:SubjectConfirmation Method="urn:oasis:names:tc:SAML:2.0:cm:beare
r" />
</saml:Subject>
<saml:Conditions NotBefore="2019-05-10T07:22:56.533Z" NotOnOrAfter="2019
-05-10T07:42:56.533Z">
  <saml:AudienceRestriction>
    <saml:Audience>https://xds-web.test.nhn.no</saml:Audience>
  </saml:AudienceRestriction>
</saml:Conditions>
<saml:AttributeStatement>
  <saml:Attribute Name="urn:oasis:names:tc:xspa:1.0:subject:subject-id">
    <saml:AttributeValue>Karoline Matre</saml:AttributeValue>
  </saml:Attribute>
  <saml:Attribute Name="urn:oasis:names:tc:xspa:1.0:subject:organization
">
    <saml:AttributeValue>Norsk Helsenet</saml:AttributeValue>
  </saml:Attribute>
  <saml:Attribute Name="urn:oasis:names:tc:xspa:1.0:subject:organization
-id">
    <saml:AttributeValue> <id xmlns="urn:hl7-org:v3" xsi:type="II" exten
sion="994598759" root="2.16.578.1.12.4.1.4.101" assigningAuthorityName="Brønnøys
undregistrene" displayable="false"/>
  </saml:AttributeValue>
</saml:Attribute>
  <saml:Attribute Name="urn:ihe:iti:xca:2010:homeCommunityId">
    <saml:AttributeValue>urn:oid:2.16.578.1.12.4.1.7.1.2</saml:Attribute
Value>
  </saml:Attribute>
  <saml:Attribute Name="urn:oasis:names:tc:xspa:2.0:subject:npi">
    <saml:AttributeValue>29019900248</saml:AttributeValue>
  </saml:Attribute>
  <saml:Attribute Name="urn:ihe:iti:xua:2017:subject:provider-identifier
">
    <saml:AttributeValue><id xmlns="urn:hl7-org:v3" type="II" extension=
"29019900248" root="2.16.578.1.12.4.1.4.1" displayable="false" />
  </saml:AttributeValue>

```

```

        </saml:Attribute>
        <saml:Attribute Name="urn:oasis:names:tc:xspa:1.0:subject:purposeofuse
">
            <saml:AttributeValue><PurposeOfUse xmlns="urn:hl7-org:v3" type="CE"
code="13" codeSystem="1.0.14265.1" codeSystemName="ISO 14265 Classification of P
urposes for processing personal health information" displayName="Subject of care
uses"/>
            </saml:AttributeValue>
        </saml:Attribute>
        <saml:Attribute Name="urn:oasis:names:tc:xacml:2.0:resource:resource-i
d">
            <saml:AttributeValue>29019900248^^^&amp;amp;2.16.578.1.12.4.1.4.1&am
p;amp;ISO</saml:AttributeValue>
            </saml:Attribute>
            <saml:Attribute Name="SecurityLevel">
                <saml:AttributeValue>4</saml:AttributeValue>
            </saml:Attribute>
            <saml:Attribute Name="Scope">
                <saml:AttributeValue>innsynregisterbruk,innsynregisterinnhold,innsyn
pasientjournal</saml:AttributeValue>
            </saml:Attribute>
        </saml:AttributeStatement>
        <saml:AuthnStatement AuthnInstant="2019-05-10T07:22:56.549Z" SessionNotO
nOrAfter="2019-05-10T07:42:56.549Z">
            <saml:AuthnContext>
                <saml:AuthnContextClassRef>urn:oasis:names:tc:SAML:2.0:ac:classes:X5
09</saml:AuthnContextClassRef>
            </saml:AuthnContext>
        </saml:AuthnStatement>
    </saml:Assertion>
</o:Security>
<Action soap:mustUnderstand="true" xmlns="http://www.w3.org/2005/08/addressi
ng">urn:ihe:iti:2007:CrossGatewayRetrieve</Action>
<MessageID xmlns="http://www.w3.org/2005/08/addressing">urn:uuid:742c7bd1-4c
79-48e4-9ba9-430227d55ae5</MessageID>
<To xmlns="http://www.w3.org/2005/08/addressing">https://sds-apigwdz-61.syke
huspartner.no/SP.Services.XCA/RespondingGatewayRetrieve.svc</To>
<ReplyTo soap:mustUnderstand="true" xmlns="http://www.w3.org/2005/08/address
ing">
    <Address>http://www.w3.org/2005/08/addressing/anonymous</Address>
</ReplyTo>
</soap:Header>
<soap:Body>
    <ns2:RetrieveDocumentSetRequest xmlns:ns6="urn:oasis:names:tc:ebxml-regrep:x
sd:lcm:3.0" xmlns:ns5="urn:oasis:names:tc:ebxml-regrep:xsd:query:3.0" xmlns:ns4=
"urn:oasis:names:tc:ebxml-regrep:xsd:rs:3.0" xmlns:ns3="urn:oasis:names:tc:ebxml
-regrep:xsd:rsm:3.0" xmlns:ns2="urn:ihe:iti:xds-b:2007">
        <ns2:DocumentRequest>
            <ns2:HomeCommunityId>2.16.578.1.12.4.1.2.5604</ns2:HomeCommunityId>
            <ns2:RepositoryUniqueId>2.16.578.1.12.4.3.1.5.20.1</ns2:RepositoryUnique
Id>
            <ns2:DocumentUniqueId>^105085430</ns2:DocumentUniqueId>
        </ns2:DocumentRequest>
    </ns2:RetrieveDocumentSetRequest>
</soap:Body>
</soap:Envelope>

```

5.8 ITI-39 response

Note: The Security header is in the example included with `mustUnderstand="0"` (false). The Security header can also be fully omitted in the response.

```
Response-Code: 200
Encoding: ISO-8859-1
Content-Type: multipart/related; type="application/xop+xml";start="<http://tempuri.org/0>";boundary="uuid:3bdff350-b338-4be6-bd04-5466a1a48ca7+id=9";start-info="application/soap+xml"
Headers: {Cache-Control=[private], Content-Length=[11073], content-type=[multipart/related; type="application/xop+xml";start="<http://tempuri.org/0>";boundary="uuid:3bdff350-b338-4be6-bd04-5466a1a48ca7+id=9";start-info="application/soap+xml"], Date=[Fri, 10 May 2019 07:22:58 GMT], MIME-Version=[1.0], Server=[Microsoft-IIS/8.5], X-AspNet-Version=[4.0.30319], X-Powered-By=[ASP.NET]}
Payload:
--uuid:3bdff350-b338-4be6-bd04-5466a1a48ca7+id=9
Content-ID: <http://tempuri.org/0>
Content-Transfer-Encoding: 8bit
Content-Type: application/xop+xml;charset=utf-8;type="application/soap+xml"
<s:Envelope xmlns:s="http://www.w3.org/2003/05/soap-envelope" xmlns:a="http://www.w3.org/2005/08/addressing" xmlns:u="http://docs.oasis-open.org/wss/2004/01/oasis-200401-wss-wssecurity-utility-1.0.xsd">
  <s:Header>
    <a:Action s:mustUnderstand="1">urn:ihe:iti:2007:CrossGatewayRetrieveResponse
  </a:Action>
    <ActivityId CorrelationId="d4c18245-a535-456f-861a-03e7b2f2a59f" xmlns="http://schemas.microsoft.com/2004/09/ServiceModel/Diagnostics">00000000-0000-0000-0000-000000000000</ActivityId>
    <a:RelatesTo>urn:uuid:742c7bd1-4c79-48e4-9ba9-430227d55ae5</a:RelatesTo>
    <a:MessageID>urn:uuid:68dcf5ad-61f7-4069-aec1-f4663f4969e1</a:MessageID>
    <o:Security s:mustUnderstand="0" xmlns:o="http://docs.oasis-open.org/wss/2004/01/oasis-200401-wss-wssecurity-secext-1.0.xsd">
      <u:Timestamp u:Id="_0">
        <u:Created>2019-05-10T07:22:58.977Z</u:Created>
        <u:Expires>2019-05-10T07:27:58.977Z</u:Expires>
      </u:Timestamp>
    </o:Security>
  </s:Header>
  <s:Body xmlns:xsi="http://www.w3.org/2001/XMLSchema-instance" xmlns:xsd="http://www.w3.org/2001/XMLSchema">
    <RetrieveDocumentSetResponse xmlns="urn:ihe:iti:xds-b:2007">
      <RegistryResponse status="urn:oasis:names:tc:ebxml-regrep:ResponseStatusType:Success" xmlns="urn:oasis:names:tc:ebxml-regrep:xsd:rs:3.0" />
      <DocumentResponse>
        <HomeCommunityId>2.16.578.1.12.4.1.2.5604</HomeCommunityId>
        <RepositoryUniqueId>2.16.578.1.12.4.3.1.5.20.1</RepositoryUniqueId>
        <DocumentUniqueId>2.16.578.1.12.4.3.1.1.20.2^105085430</DocumentUniqueId>
      </DocumentResponse>
      <Document>
        <xop:Include href="cid:http://tempuri.org/1/636930769789779713" xmlns:xop="http://www.w3.org/2004/08/xop/include" />
      </Document>
    </s:Body>
</s:Envelope>
```

```

    </DocumentResponse>
  </RetrieveDocumentSetResponse>
</s:Body>
</s:Envelope>
--uuid:3bdff350-b338-4be6-bd04-5466a1a48ca7+id=9
Content-ID: <http://tempuri.org/1/636930769789779713>
Content-Transfer-Encoding: binary
Content-Type: application/octet-stream
<ClinicalDocument classCode="DOCCLIN" moodCode="EVN" xmlns="urn:hl7-org:v3" xmlns:voc="urn:hl7-org:v3/voc">
  <realmCode code="NO" />
  <typeId extension="POCD_HD000040" root="2.16.840.1.113883.1.3" />
  <templateId root="2.16.578.1.34.10.123" />
  <id extension="105085430" root="2.16.578.1.12.4.3.1.1.20.2" />
  <code code="B03-2" displayName="Poliklinisk notat" codeSystem="2.16.578.1.12.4.1.1.9602" />
  <title>Poliklinisk notat...</title>
  <effectiveTime value="20190402134909" />
  <confidentialityCode code="N" codeSystem="2.16.840.1.113883.5.25" />
  <languageCode code="no-NO" />
  <setId extension="105085430" root="2.16.578.1.12.4.3.1.1.20.2.15.1001" />
  <recordTarget typeCode="RCT" contextControlCode="OP">
    <patientRole classCode="PAT">
      <id extension="29019900248" root="2.16.578.1.12.4.1.4.1" />
      <patient classCode="PSN" determinerCode="INSTANCE">
        <name>
          <given>Karoline</given>
          <family>Testpasient Matre</family>
        </name>
        <administrativeGenderCode code="2" codeSystem="2.16.578.1.12.4.1.1.3101" displayName="Female" />
        <birthTime value="19990129" />
      </patient>
      <providerOrganization classCode="ORG" determinerCode="INSTANCE">
        <id extension="108604" root="2.16.578.1.12.4.1.4.102" />
        <name>Kirurgi Hamar</name>
        <asOrganizationPartOf>
          <wholeOrganization>
            <id extension="983971709" root="2.16.578.1.12.4.1.4.101" />
            <name>Sykehuset Innlandet HF</name>
          </wholeOrganization>
        </asOrganizationPartOf>
      </providerOrganization>
    </patientRole>
  </recordTarget>
  <author typeCode="AUT" contextControlCode="OP">
    <time value="20190402134930" />
    <assignedAuthor classCode="ASSIGNED">
      <id extension="UXBONI" root="2.16.578.1.12.4.1.4.4" />
      <assignedPerson>
        <name>
          <given>Nina</given>
          <family>Bonn</family>
        </name>
      </assignedPerson>
    </assignedAuthor>
  </author>
  <custodian typeCode="CST">

```



```

0IDYxMSA2NjcgNjY3IDY2NyA2NjcgNjY3IDY2NyAxMDAwIDcyMiA2NjcKjY3IDY2NyA2NjcgMjc4IDI
30CAyNzggMjc4IDcyMiA3MjIgcNzc4IDc3OCA3NzggNzc4IDc3OCA1ODQgNzc4IDcyMiA3MjIgcNzc4IDYyNy
yMiA2NjcgNjY3IDYxMSA1NTYgNTU2IDU1NiA1NTYgNTU2IDU1NiA4ODkgNTAwIDU1NiA1NTYgNTU2IDU
1NiA2NjcgMjc4IDI3OAoyNzggNTU2IDU1NiA1NTYgNTU2IDU1NiA1NTYgNTU2IDU0OSA2MTEgNTU2IDU
1NiA1NTYgNTU2IDUwMCA1NTYgNTAwIF0NCmVuZG9iaG9iaG9iaG9iaG9iaG9iaG9iaG9iaG9iaG9iaG9iaG
yaXB0b3IKL0Zvb3Rlc2NjYzIDYyNyA2NjcgNjY3IDYyNyA2NjcgNjY3IDYyNyA2NjcgNjY3IDYyNyA2Njcg
yMTAKL0ZsYWd0IDYyNyA2NjcgNjY3IDYyNyA2NjcgNjY3IDYyNyA2NjcgNjY3IDYyNyA2NjcgNjY3IDYyNy
2NjYzIDYyNyA2NjcgNjY3IDYyNyA2NjcgNjY3IDYyNyA2NjcgNjY3IDYyNyA2NjcgNjY3IDYyNyA2NjcgNjY
lYWRpbmcgMTUwIDYyNyA2NjcgNjY3IDYyNyA2NjcgNjY3IDYyNyA2NjcgNjY3IDYyNyA2NjcgNjY3IDYyNy
lYWRpbmcgMTUwIDYyNyA2NjcgNjY3IDYyNyA2NjcgNjY3IDYyNyA2NjcgNjY3IDYyNyA2NjcgNjY3IDYyNy
SCI9GaxJzdENoYXJzIDYyNyA2NjcgNjY3IDYyNyA2NjcgNjY3IDYyNyA2NjcgNjY3IDYyNyA2NjcgNjY3IDY
vciA3IDAgUg0KjY3IDYyNyA2NjcgNjY3IDYyNyA2NjcgNjY3IDYyNyA2NjcgNjY3IDYyNyA2NjcgNjY3IDY
dDQovRm9udCA8PCAvRjEgOCAFwUzIDYyNyA2NjcgNjY3IDYyNyA2NjcgNjY3IDYyNyA2NjcgNjY3IDYyNyA
lDQovUGFyZW50IDYyNyA2NjcgNjY3IDYyNyA2NjcgNjY3IDYyNyA2NjcgNjY3IDYyNyA2NjcgNjY3IDYyNy
gWzAgMCA1OTUwIDYyNyA2NjcgNjY3IDYyNyA2NjcgNjY3IDYyNyA2NjcgNjY3IDYyNyA2NjcgNjY3IDYyNy
+IA1lbnRvYmoNCjEgOCAFwUzIDYyNyA2NjcgNjY3IDYyNyA2NjcgNjY3IDYyNyA2NjcgNjY3IDYyNyA2Njcg
0IDENCj4+IA1lbnRvYmoNCjEgOCAFwUzIDYyNyA2NjcgNjY3IDYyNyA2NjcgNjY3IDYyNyA2NjcgNjY3IDY
nIDEWIDAgUg0KjY3IDYyNyA2NjcgNjY3IDYyNyA2NjcgNjY3IDYyNyA2NjcgNjY3IDYyNyA2NjcgNjY3IDY
0cnVjdC9QIDE0IDAgUg0KjY3IDYyNyA2NjcgNjY3IDYyNyA2NjcgNjY3IDYyNyA2NjcgNjY3IDYyNyA2Njcg
kb2JqDQovRm9udCA8PCAvRjEgOCAFwUzIDYyNyA2NjcgNjY3IDYyNyA2NjcgNjY3IDYyNyA2NjcgNjY3IDY
gL1R5cGUvRm9udCA8PCAvRjEgOCAFwUzIDYyNyA2NjcgNjY3IDYyNyA2NjcgNjY3IDYyNyA2NjcgNjY3IDY
hcmVudFRyZW50IDYyNyA2NjcgNjY3IDYyNyA2NjcgNjY3IDYyNyA2NjcgNjY3IDYyNyA2NjcgNjY3IDYyNy
vUGFnZXMGMA1OTUwIDYyNyA2NjcgNjY3IDYyNyA2NjcgNjY3IDYyNyA2NjcgNjY3IDYyNyA2NjcgNjY3IDY
0IDAgUg0KjY3IDYyNyA2NjcgNjY3IDYyNyA2NjcgNjY3IDYyNyA2NjcgNjY3IDYyNyA2NjcgNjY3IDYyNy
KMCAXOA0KMDAwMDAwMDAwMCA2NTUzNSBmDQowMDAwMDAwMDYwIDAwMDAwMDAwMDAwMDAwMDAwMDAwMDAwMD
wMDAgbg0KMDAwMDAwMDAwMjA4MiAwMDAwMDAwMDAwMDAwMDAwMDAwMDAwMDAwMDAwMDAwMDAwMDAwMDAwMD
wMDAgbg0KMDAwMDAwMDAwMjE3NSAwMDAwMDAwMDAwMDAwMDAwMDAwMDAwMDAwMDAwMDAwMDAwMDAwMDAwMD
wMDAgbg0KMDAwMDAwMDAwMzUxNiAwMDAwMDAwMDAwMDAwMDAwMDAwMDAwMDAwMDAwMDAwMDAwMDAwMDAwMD
wMDAgbg0KMDAwMDAwMDAwMzgxMSAwMDAwMDAwMDAwMDAwMDAwMDAwMDAwMDAwMDAwMDAwMDAwMDAwMDAwMD
wMDAgbg0KMDAwMDAwMDAwMzk1MiAwMDAwMDAwMDAwMDAwMDAwMDAwMDAwMDAwMDAwMDAwMDAwMDAwMDAwMD
wMDAgbg0KdHJhaWxlcnRvIDYyNyA2NjcgNjY3IDYyNyA2NjcgNjY3IDYyNyA2NjcgNjY3IDYyNyA2NjcgNjY
zNGE4YzA1ZTI5MDI2IDYyNyA2NjcgNjY3IDYyNyA2NjcgNjY3IDYyNyA2NjcgNjY3IDYyNyA2NjcgNjY3ID
mbyAyIDAgUg0KjY3IDYyNyA2NjcgNjY3IDYyNyA2NjcgNjY3IDYyNyA2NjcgNjY3IDYyNyA2NjcgNjY3IDY
</languageCode code="no-NO" />
</nonXMLBody>
</component>
</ClinicalDocument>
--uuid:3bdff350-b338-4be6-bd04-5466a1a48ca7+id=9--

```

5.9 AuditEvent for ITI-18 initiated from a Document Consumer

NB: This example is synthetically generated and not tested or validated against IHE ATNA or HL7 FHIR Auditevent.

```

<?xml version="1.0" encoding="UTF-8"?>
<!-- Created with Liquid Technologies Online Tools 1.0 (https://www.liquid-technologies.com) -->
<AuditEvent xmlns="http://hl7.org/fhir">
  <id value="Auditevent ITI-18 Document Consumer Example" />
  <text>
    <status value="synthetic generated" />
  </text>
  <type>
    <system value="http://dicom.nema.org/resources/ontology/DCM" />

```

```

    <code value="110112" />
    <display value="Query" />
  </type>
  <subtype>
    <system value="urn:oid:1.3.6.1.4.1.19376.1.2" />
    <code value="ITI-18" />
    <display value="Registry Stored Query" />
  </subtype>
  <action value="E" />
  <recorded value="2015-08-26T23:42:24Z" />
  <purposeOfEvent>
    <coding>
      <system value="1.0.14265.1" />
      <code value="1" />
      <display value=" Clinical care provision to an individual subject of care"
    />
    </coding>
    <text value="ISO 14265 Classification of Purposes for processing personal he
alth information " />
  </purposeOfEvent>
  <outcome value="0" />
  <!--The Human using the software, if known -->
  <agent>
    <type>
      <coding>
        <system value="http://terminology.hl7.org/CodeSystem/extra-security-role
-type" />
        <code value="humanuser" />
        <display value="human user" />
      </coding>
    </type>
    <who>
      <identifier>
        <system value="urn:oid:2.16.578.1.12.4.1.4.2" />
        <value value="13116900216" />
      </identifier>
    </who>
    <name value="Line Linedanser" />
    <requestor value="true" />
  </agent>
  <agent>
    <!--The Source system that initiated the request -->
    <type>
      <coding>
        <system value="http://dicom.nema.org/resources/ontology/DCM" />
        <code value="110153" />
        <display value="Source" />
      </coding>
    </type>
    <who>
      <identifier>
        <system value="urn:oid:2.16.578.1.12.4.1.4.101" />
        <value value="915933149" />
      </identifier>
    </who>
    <name value="Helsenorge portal" />
    <requestor value="false" />
  </network>

```



```

    <address value="www.helsenorge.no" />
    <type value="1" />
  </network>
</agent>
<agent>
  <!--The Destination system -->
  <type>
    <coding>
      <system value="http://dicom.nema.org/resources/ontology/DCM" />
      <code value="110152" />
      <display value="Destination" />
    </coding>
  </type>
  <who>
    <identifier>
      <system value="urn:oid:2.16.578.1.12.4.1.4.101" />
      <value value="915933149" />
    </identifier>
  </who>
  <name value="National XCA gateway" />
  <requestor value="false" />
  <network>
    <address value="xca.ehelse.no" />
    <type value="1" />
  </network>
</agent>
<source>
  <observer>
    <reference value="http://nhn.no" />
    <type value="Organization" />
    <display value="Norsk Helsnett" />
  </observer>
</source>
<entity>
  <what>
    <identifier>
      <value value="29019900248^^^&amp;2.16.578.1.12.4.1.4.1&amp;ISO" />
    </identifier>
  </what>
  <type>
    <system value="http://terminology.hl7.org/CodeSystem/audit-entity-type" />
    <code value="1" />
    <display value="Person" />
  </type>
  <role>
    <system value="http://terminology.hl7.org/CodeSystem/object-role" />
    <code value="1" />
    <display value="Patient" />
  </role>
</entity>
<entity>
  <what>
    <Reference value="urn:uuid:14d4debf-8f97-4251-9a74-a90016b0af0d" />
    <coding>
      <system value="IHE transactions" />
      <code value="ITI-18" />
      <display value="Registry Stored Query" />
    </coding>
  </what>

```

```
</what>
<type>
  <system value="http://terminology.hl7.org/CodeSystem/audit-entity-type" />
  <code value="2" />
  <display value="System Object" />
</type>
<role>
  <system value="http://terminology.hl7.org/CodeSystem/object-role" />
  <code value="24" />
  <display value="Query" />
</role>
<query value=" PG5zNDpBZGhvY1F1ZXJ5UmVxdWVzdCB4bWxuczpuczY9InVybjpvYXNpczpuY
W1lczp0YzplYnhtbC1yZWdyZXAx6eHNkOmxjbTozLjAiIHhtbG5zOm5zNT0idXJuOmloZTppdGk6eGRzL
WI6MjAwNyIgeG1sbnM6bnM0PSJ1cm46b2FzaXM6bmFtZXM6dGM6ZWJ4bWwtcmVncmVwOnhzZDpxdWVye
TozLjAiIHhtbG5zOm5zMz0idXJuOm9hc2lzOm5hbWVzOnRjOmVieG1sLXJlZ3JlcDp4c2Q6cnM6My4wI
iB4bWxuczpuczI9InVybjpvYXNpczpuYW1lczp0YzplYnhtbC1yZWdyZXAx6eHNkOnJpbTozLjAiPjxuc
zQ6UmVzcG9uc2VpCHRpb24gcmV0dXJuVHlwZT0iT2JqZWN0UmVmIiByZXR1cm5Db21wb3NlZE9iamVjd
HM9InRydWUiLz48bnMyOkFkaG9jUXVlcnkgaWQ9InVybjpldWlkOjE0ZDRkZWJmLThmOTctNDI1MS05Y
Tc0LWE5MDAxNmIwYWYwZCI+PG5zMjpTbG90IG5hbWU9IiRYRFNEb2N1bWVudEVudHJ5Q29uZmlkZW50a
WFsaXR5Q29kZSI+PG5zMjpwYX1ZUxpc3Q+PG5zMjpwYX1ZT4oJ0xeXjIuMTYuODQwLjEuMTEzODgzL
jUuMjUnKTwvbnMyOlZhbHVlPjxuczI6VmFsdWU+KCdNX14yLjE2Ljg0MC4xLjExMzQ4My41LjI1Jy8L
25zMjpwYX1ZT48bnMyOlZhbHVlPignT15eMi4xNi44NDAuMS4xMTM4ODMuNS4yNScpPC9uczI6VmFsd
WU+PG5zMjpwYX1ZT4oJ1VeXjIuMTYuODQwLjEuMTEzODgzLjUuMjUnKTwvbnMyOlZhbHVlPjxuczI6V
mFsdWU+KCdSX14yLjE2Ljg0MC4xLjExMzQ4My41LjI1Jy8L25zMjpwYX1ZT48L25zMjpwYX1ZUxpc
3Q+PC9uczI6U2xvdD48bnMyOlNsb3QgYmFtZT0iJFhEU0RvY3VtZW50RW50cnlQYXRpZW50SWQiPjxuc
zI6VmFsdWVMaXN0PjxuczI6VmFsdWU+JzEyMTE5MDAwNDY1X15eJmFtcDsyLjE2LjU3OC4xLjEyLjQuM
S40LjEmYW1wO01TTyc8L25zMjpwYX1ZT48L25zMjpwYX1ZUxpc3Q+PC9uczI6U2xvdD48bnMyOlNsb
3QgYmFtZT0iJFhEU0RvY3VtZW50RW50cnlTdGF0dXMiPjxuczI6VmFsdWVMaXN0PjxuczI6VmFsdWU+K
Cd1cm46b2FzaXM6bmFtZXM6dGM6ZWJ4bWwtcmVncmVwOln0YXR1c1R5cGU6QXBwcm92ZWQnKTwvbnMyO
lZhbHVlPjwvbnMyOlZhbHVlTG1zdD48L25zMjpwYX1ZUxpc3Q+PC9uczI6U2xvdD48bnMyOlNsb3QgY
mFtZT0iJFhEU0RvY3VtZW50RW50cnlTdGF0dXMiPjxuczI6VmFsdWVMaXN0PjxuczI6VmFsdWU+K
2NRdWVyeVJlcXVlc3Q+" />
  </entity>
</AuditEvent>
```

 Direktoratet for e-helse

Besøksadresse

Verkstedveien 1
0277 Oslo

Kontakt

postmottak@ehelse.no